

Fusion7[™]

All-in-One Cellular, Wi-Fi, and HDTV Booster Kit

User Guide



Thank you for purchasing SureCall’s Fusion7 all-in-one cellular, Wi-Fi and HDTV signal booster. Fusion7 was specifically designed to eliminate frustrations over dropped calls, slow 4G data and limited Wi-Fi range, as well as, provide the option to bring locally aired HDTV stations and enhanced streaming video through Netflix® and other on-demand streaming media providers.

If you have any questions during setup, please reach out to our US-based experienced support technicians:

Call: 1-888-365-6283

Email: support@surecall.com

Or, **chat:** www.surecall.com, 7:00 am – 5:00 pm PST, Monday – Friday



Watch installation, optimization and troubleshooting techniques in our SureCall University YouTube channel



@SureCall



Stay up to date with all things SureCall

How It Works

Cellular:

SureCall’s Fusion7 cellular boosting function uses a high-quality bidirectional signal booster that enhances signals to areas that are prone to weak cellular coverage. The cellular component of the Fusion7 works with two types of antennas:

- 1) An outdoor antenna that communicates with the cell tower.
- 2) A set of Indoor antennas that communicate with your mobile devices.

Signals sent from a cell tower are received by the outdoor antenna, amplified by the booster and then sent to your phone via the indoor antennas. When your phone transmits, the signal is sent to the indoor antennas, and then sent to the cell tower via the outdoor antenna.

Wi-Fi:

The Wi-Fi component of the Fusion7 works by connecting your external modem to the WAN port on the Fusion7 with an Ethernet cable (not provided). The booster will then extend your existing Wi-Fi throughout the coverage area.

HDTV:

The optional HDTV components (not shown in illustration) of the Fusion7 work with one of two HDTV antenna options. HDTV broadcasts are picked up by the antenna and boosted through the Fusion7, which connects directly to up to two HDTV devices through RG6 cable (and supports up to 25 devices via cable splitters). This enables the television to access a greater number of high-definition television stations.

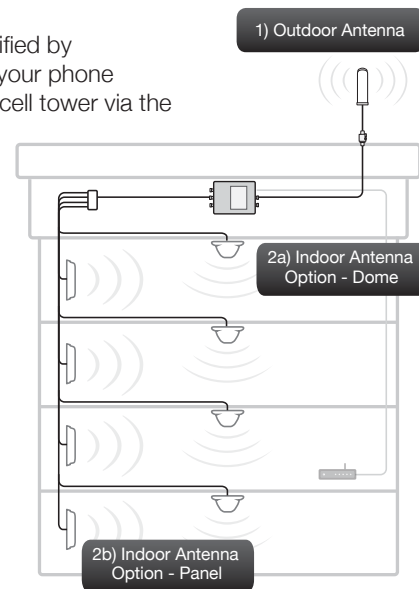

Table of Contents

How It Works	2
Package Contents	4
Kit Options	6
Before Installation	7
Installation Overview.....	7
Section 1: Cellular Component Installation.....	8
Step 1. Find the area with the Strongest Signal	8
Step 2. Install the Outdoor Antenna	8
Step 3. Install the Indoor Antennas	10
Option A: Install Indoor Dome Antennas	10
Option B: Install Indoor Panel Antennas.....	11
Step 4. Install the Signal Booster	13
Booster Hardware.....	14
Configure Gain Settings.....	14
If you Want to Improve Cellular Coverage.....	15
Section 2: Wi-Fi Connection	15
Section 3: HDTV Installation	15
Troubleshooting	16
LED Indicators	16
Specifications	18
Kitting Information	19
Three-Year Product Warranty	20
FCC, IC and Safety Information.....	20











Package Contents

1. Unpack all package contents. For missing or damaged items, contact your reseller. Keep the carton and packing material to store the product in case you need to return it.
2. Turn over the signal booster and record the model and serial number for reference:





Serial #: _____

Purchase Date: _____

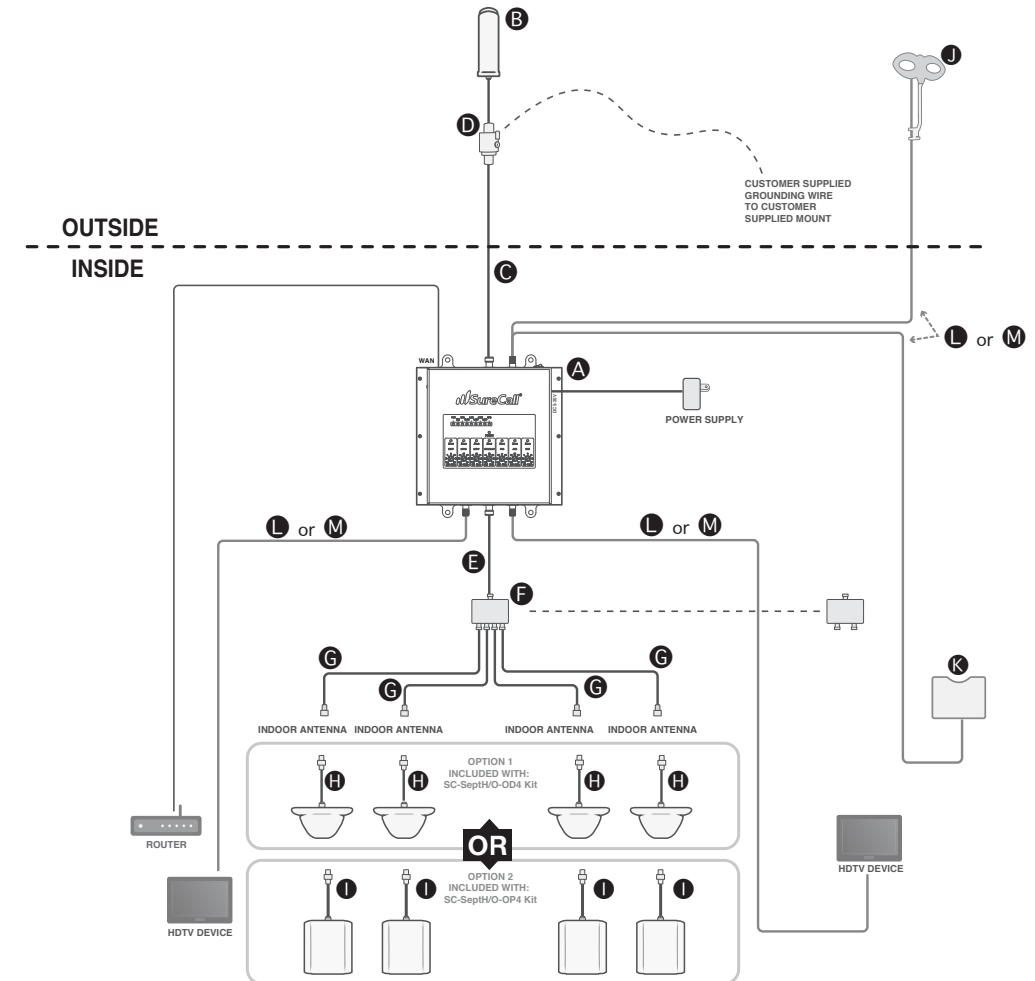
Standard Fusion7 signal booster packages include the following items:

Ref.	QTY	Description	Image
Included in both standard kits			
A	1/ea	SureCall Fusion7 booster and power supply	
B	1	Outdoor omni antenna (SC-288W)	
C	1	75 ft. length of SC-400 NN coax cable (connects the booster to the outdoor antenna) (SC-001-75)	
D	1/ea	Lightning protector (SC-LP) and 2 ft. SC-400 NN cable (connects to Lightning protector) (SC-001-02)	
E	1/ea	4-Way splitter (SC-WS-4-TNC) and optional 2-Way splitter (SC-WS-2-TNC)	
F	1	30 ft. cable to connect to splitter (SC-001-30-TNC)	
G	4	75 ft. length of SC-400 TNC coax cable (connects the booster to the indoor antennas) (SC-001-75-TNC)	
not shown	4	Optional TNC crimp connectors for shortening indoor cable lengths, if needed (SC-CN-09-TNC)	
Included in kit SC-SEPTH/OD4-Kit			
H	4	Indoor dome antenna (SC-222W-TNC)	
Included in kit SC-SEPTH/OP4-Kit			
I	4	Indoor panel antenna (SC-248W-TNC)	





HDTV Boosting Accessories (not included)			
J	1	High-performing outdoor antenna option recommended for spaces with interior walls or obstacles (only one HDTV antenna needed per kit) (SC-306W-H)	
K	1	Indoor panel antenna option recommended for open indoor spaces (only one HDTV antenna needed per kit) (SC-305W-H)	
L	varies by need	RG6 - 50 ft. May be used to connect booster to chosen HTDV antenna -- connect the booster to HDTV device (SC-RG6-50)	
M	varies by need	RG6 - 75 ft. May be used to connect booster to chosen HTDV antenna -- connect the booster to HDTV device (SC-RG6-75)	

Kit Options

Fusion7 is available in four kits that are customized to your particular needs. Please determine which kit you have from the following list:

Model No.	Usage Coverage
SC-SEPTH/OD4-Kit	(1) Fusion7 Booster and power supply, (1) Omni Outdoor Antenna (SC-288W), (4) Dome Antennas (SC-222W-TNC), (4) 75 ft. SC-400 Cable (SC-001-75-TNC), (1) 4-Way Splitter (SC-WS-4-TNC), (1) optional 2-Way Splitter (SC-WS-2-TNC), (1) Lightning Protector (SC-LP) (N Connectors), (1) 2 ft. SC-400 NN Cable to Lightning Protector (SC-001-02), (1) 30 ft. SC-400 Cable to 4-Way Splitter (SC-001-30-TNC), (1) 75 ft. SC-400 NN Cable to outdoor antenna (SC-001-75), (4) Optional TNC Male Crimp Connector (SC-CN-09-TNC)
SC-SEPTH/OP4-Kit	(1) Fusion7 Booster and power supply, (1) Omni Outdoor Antenna (SC-288W), (4) Panel Antennas (SC-248W-TNC), (4) 75 ft. SC-400 Cable (SC-001-75-TNC), (1) 4-Way Splitter (SC-WS-4-TNC), (1) optional 2-Way Splitter (SC-WS-2-TNC), (1) Lightning Protector (SC-LP) (N Connectors), (1) 2 ft. SC-400 NN Cable to Lightning Protector (SC-001-02), (1) 30 ft. SC-400 Cable to 4-Way Splitter (SC-001-30-TNC), (1) 75 ft. SC-400 NN Cable to outdoor antenna (SC-001-75), (4) Optional TNC Male Crimp Connector (SC-CN-09-TNC)

For a detailed description, see Kitting Information on page 19.

	Antenna Type	Model No.	Usage Coverage
	Outdoor Omni Antenna	SC-288W	Omni antennas are the ideal solution for sending/receiving signal from all directions.
	Indoor Dome Antenna	SC-222W-TNC	Dome antennas, generally ceiling-mounted, are omni-directional, sending/receiving signal in all directions indoors.
	Indoor Panel Antenna	SC-248W-TNC	Panel antennas, generally wall-mounted, provide directional indoor coverage.

Note: Due to the recent change of our company name from Cellphone-Mate (CM) to SureCall (SC) we have changed the prefix on all of our antennas, cables and accessories from CM to SC-.

Before Installation

Before installation, make note of these important factors:

- **A “soft install” is recommended for each section of your installation before permanent placement of parts.**
- The booster will need to be close enough to an existing electrical outlet.
- A minimum of 50 ft. of separation between the outdoor antenna and indoor antennas is recommended.
- There will need to be sufficient cable length between planned outdoor antenna location and booster connector.
- There will need to be sufficient cable length between planned indoor antenna location and booster connector. Additional cable may be purchased if needed.
- Ethernet cable of adequate length is needed to connect the booster to your wireless router. One has not been provided.

Installation Overview

Cellular:

1. Find the outside area that has the strongest signal. (See page 8).
2. Install the outdoor antenna in the area identified in step 1. (See page 8).
3. Install the indoor antennas where increased signal is needed. (See page 11).
4. Mount the signal booster, connect the outdoor and indoor antenna cables to the signal booster, and connect the booster to an AC power source. (See page 13).

Wi-Fi:

1. Connect your router to WAN port on the booster using an Ethernet cable.
2. Power on the booster. The WAN and WLAN lights on the Fusion7 status LEDs will light up.
3. On your Wi-Fi device, search available wireless networks and choose 11n AP, a security password isn't needed.
4. Create a secure password.

HDTV (These parts are available as accessories and not included in your kit):

1. Mount your chosen HDTV antenna (either SC-305W-H or SC-306W-H) in a location appropriate for the chosen antenna.
2. Connect the HDTV antenna to the booster port labeled HDTV OUTSIDE using RG6 cable.
3. Booster ports on the other end labeled HDTV1 and HDTV2 are used to connect the booster directly to your HDTV devices using RG6 cable. Up to 25 HDTV devices can be supported using cable splitters.

FCC 27.5 (d)(4) Statement: Fixed, mobile, and portable (hand-held) stations operating in the 1710-1755 MHz band as well as mobile and portable stations operating in the 1695-1710 MHz and 1755-1780 MHz bands are limited to 1 watt EIRP. Fixed stations operating in the 1710-1755 MHz band are limited to a maximum antenna height of 10 meters above ground. Mobile and portable stations operating in these bands must employ a means for limiting power to the minimum necessary for successful communications.

SECTION 1: CELLULAR COMPONENT INSTALLATION

Step 1. Find the area with the Strongest Signal

Finding Your Strongest Cellular Signal

To send and receive cell phone calls you need to have an adequate cellular signal. This usually means having to be somewhat close to a cell phone tower. Your cellular signal is measured in decibels (dB), which represents the power of the signal. Signal readings appear as a negative number, for example -85 dB. The stronger your signal is the closer it gets to zero. As the illustration below shows a -50 dB signal reading is very strong while a signal reading of -100 dB and above is very weak.

How to Determine Your dB Signal Reading

- Using an iPhone: Dial *3001#12345#*, a Field Test screen will appear press down on the home button for a few seconds so your dB reading will appear in the upper left hand corner.
- Using an Android: Download the "Network Signal Info" within the Google Play store. Once installed, you will be able to view your dB strength.
- Internet: Go to: www.speedtest.net to test your 3G and 4G data rates.

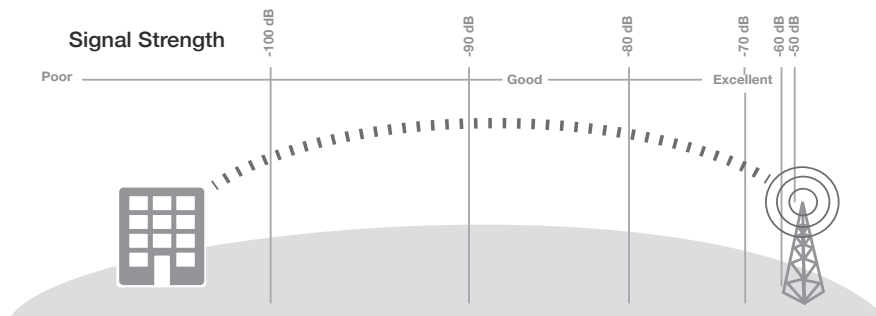

Step 2. Install the Outdoor Antenna

The omni antenna may be mounted directly to a surface or to a J-mount pole(not included). Outdoor omni antennas receive and send signals in a 360° radius. If you are installing a Yagi antenna, set it up facing the cellular tower to find the nearest cell tower go to www.antennasearch.com. Place the antenna as high as possible. Make sure that the mounting area has at least a 36-inch radius clear of obstructions and other radiating elements. The antenna should be mounted in an upright position. See illustration.

Note: Do not collocate antennas or operate the outdoor antenna with any other antenna or signal booster.

1. Unscrew antenna from L-mounting bracket on antenna base with hands, or wrench, if needed.
2. Using vertical plate of bracket, mark position of desired placement with pencil or marker.
3. Unscrew nut on end of stucco screw and remove it along with lock washer and regular washer.
4. Place vertical plate into desired location and tap the screws head first, along with sleeve, into stucco 1/2" to 5/8" deep into place.

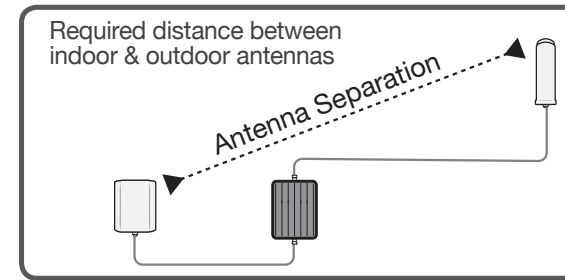

Outdoor/ Indoor Antenna Separation
A minimum of 50 ft. of separation between the outdoor antenna and indoor antennas is recommended for best performance.
Reducing antenna separation will reduce the coverage provided by the booster and generally, additional separation will provide better performance.

5. In this order, place washer, lock washer and nut on each screw and tighten until secure. When tightening screw, sleeve will expand to secure plate. Screw antenna securely back onto horizontal plate.
6. Connect antenna to cable connector of one of the 75 ft. lengths of SC-400 cable and run along route to planned location of your booster.

Outdoor Antenna Surface Mount

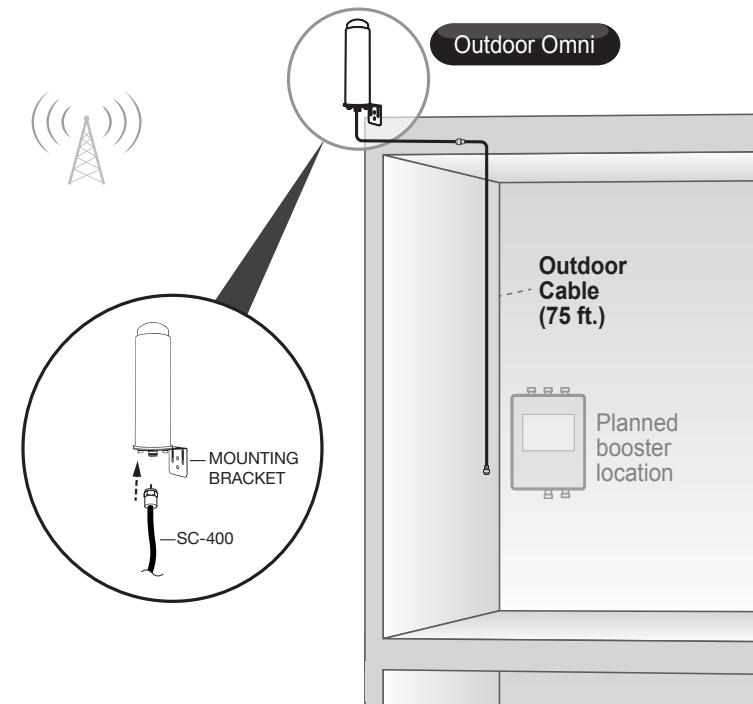
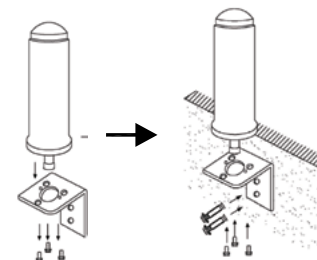

IMPORTANT: For boosters enhancing T-Mobile's AWS frequencies, the FCC has stated for consumer signal boosters operating as a fixed station in the 1710 - 1755 MHz uplink 2110 - 2155 downlink bands, the users or installation manual must contain the 30 foot height restriction requirements per FCC 27.50(d)(4).

Step 3. Install the Indoor Antennas

Indoor antennas for the Fusion7 come with either four omni-directional domes or four directional panels.

- For indoor dome antennas, mount on a ceiling in a central location where signal is needed.
- For indoor panel antennas, mount on a wall or surface facing the area where signal is needed. These directional antennas should always point away from the outdoor antenna. To avoid interference, retain a minimum distance of 3 feet from panel antennas.

Option A: Install Indoor Dome Antennas

The indoor dome multi-band plastic antenna is an omni-directional interior antenna that gathers and sends signals from all sides. Range of antenna is dependent on three factors:

1. Physical obstructions
2. Power generated by booster
3. Signal level received by the outdoor antenna
4. Cable length

Besides the antenna itself, parts include mounting equipment for either a flat horizontal surface or a wall. It should be mounted in an upright position for best results. You can also install your interior antenna above the ceiling panel provided there are not materials that could obstruct signals.

For Each Indoor Dome Antenna:

1. Drill a 20 mm diameter hole in the ceiling. The ceiling thickness should be 20 mm, maximum.
2. Unscrew fixing nut from antenna. Place antenna cable through hole. Screw the fixing nut back onto antenna and cable on crawl space side of ceiling and fasten.
3. Connect antenna to cable connector of one of the four 75 ft. lengths of SC-400-75-TNC cable and run along route to planned location of your booster's 4 way splitter. Note: Should there be an excessive length of unneeded cable, optional TNC cable crimpers have been provided in order to shorten the cable.
4. Tighten fixing nut to secure antenna (do not over-tighten).
5. Once all indoor antennas and cables are in place, connect cable runs from indoor antennas to the 4-way splitter ports. Note: an optional 2-way splitter has been provided if only 2 indoor antennas are being used.
6. Connect the provided 30 ft. of SC-400 cable to the remaining end of the splitter and route cable to the planned location of your booster.

Note: Be sure to provide the minimum 50 ft. of separation from outdoor antenna (see table on page 9).

Important:

- Storage and transportation: Store and place in non-extreme room-temperature and dry environment
- This antenna should not be used near open fire or flame.

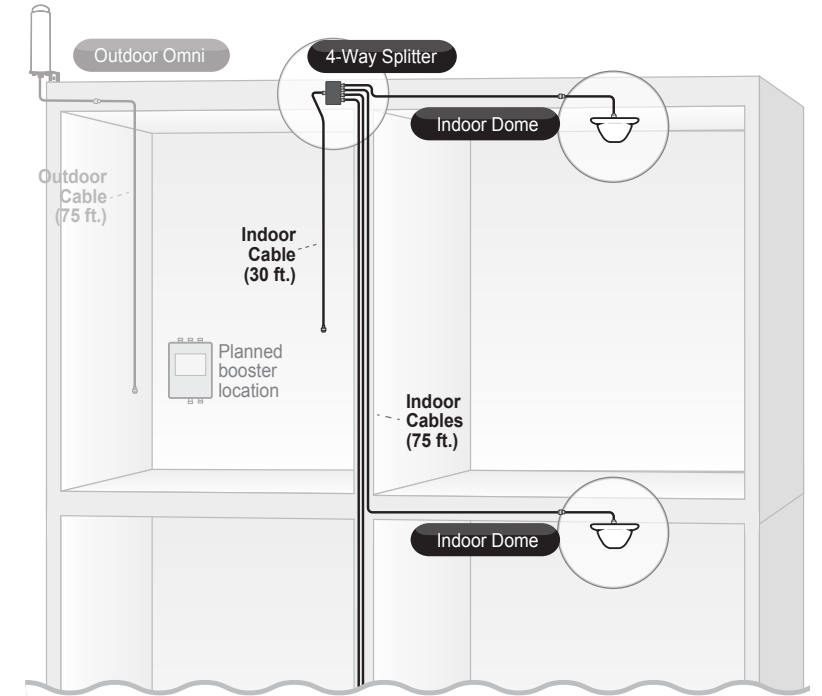
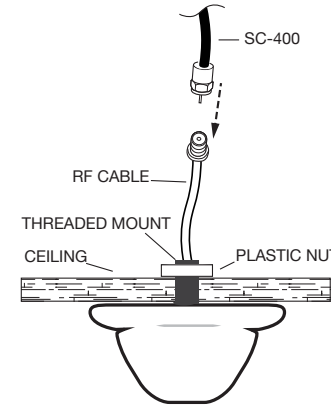

Option B: Install Indoor Panel Antennas

The provided panel antennas are multi-band directional antennas with a 120° reach. They should be mounted facing the area signal is needed. It is also important that they do not point toward the outdoor antenna. Range of antenna is dependent on three factors:

1. Physical obstructions
2. Power generated by booster
3. Signal level received by the outdoor antenna
4. Cable length

Besides the antenna itself, parts include mounting equipment for a flat horizontal surface. You can also install your interior antenna behind a wall or above a ceiling panel provided there are not materials that could obstruct signals.

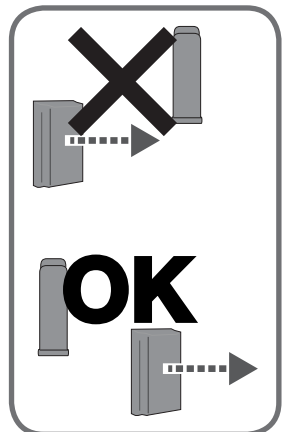

For Each Indoor Panel Antenna:

1. Choose location for mounting antenna on vertical surface. Ideal height off the ground or floor should be the approximate height of regular cell phone use.
2. Using plate, mark position of desired screw placement with pencil or marker.
3. Screw mounting plate into place with the slide panel protruding towards you.
4. Slide antenna securely onto mounting plate.
5. Connect antenna's RF cable to the cable connector of one of the four 75 ft. lengths of SC-400-75-TNC cable and run along route to planned location of your booster's 4 way splitter. Note: Should there be an excessive length of unneeded cable, optional TNC cable crimpers have been provided in order to shorten the cable.
6. Once all indoor antennas and cables are in place, connect cable runs from indoor antennas to the 4-way splitter ports. Note: an optional 2-way splitter has been provided if only 2 indoor antennas are being used.
7. Connect the provided 30 ft. of SC-400 cable to the remaining end of the splitter and route cable to the planned location of your booster.

Note: Be sure to provide the minimum 50 ft. of separation from outdoor antenna (see table on page 9).

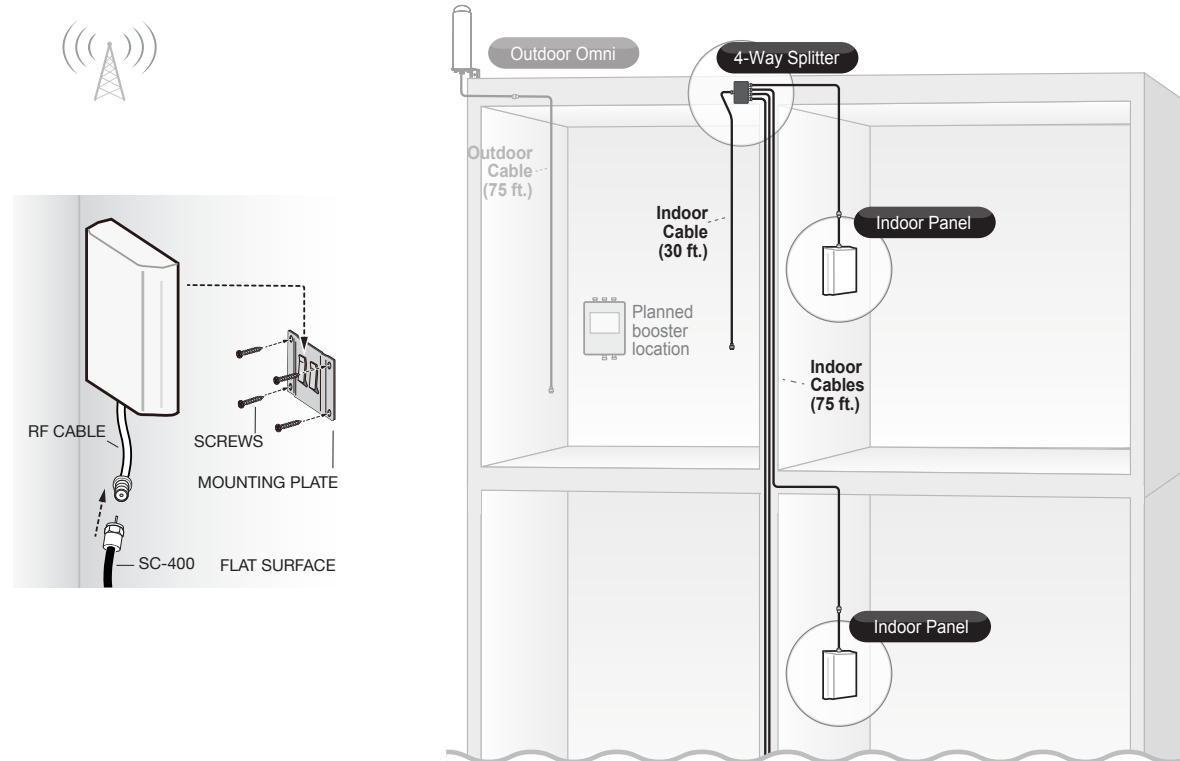

Note: If desired surface for installation plate is wood or concrete, wood or masonry screws for L-plate will have to be purchased separately.

Step 4. Install the Signal Booster

1. When placing the booster, select a location close to a working AC outlet. Do not expose the signal booster to excessive heat, direct sunlight, moisture, and airtight enclosures.
2. If you'd like to mount the booster to a wall, mark location of screw tabs on the wall in the desired location. Use supplied screws or appropriate screws for surface of mounting location and drill through screw tab holes on booster.
3. Connect the outdoor antenna cable to the signal booster connector port marked OUTSIDE and hand-tighten the connection.
4. Connect the cable coming from the indoor antennas' 4-way splitter to the booster port marked INSIDE (see page 14) and hand-tighten the connection.
5. Connect the AC power cord to the signal booster.
6. Connect the plug on the other end of the 110V AC power outlet.
7. Turn the booster's power switch on.

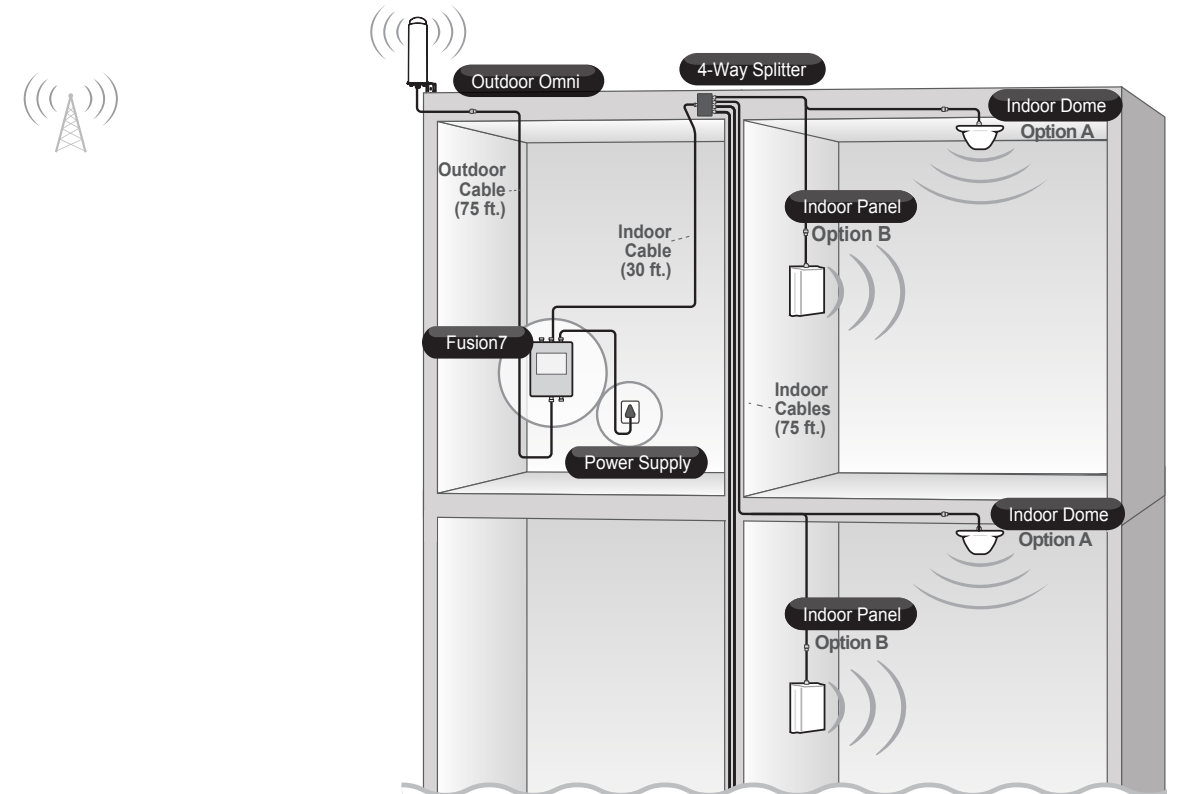

Note: If the Power LED does not turn ON or the Alert LEDs continue to flash, (see page 16). This booster is rated for 5-20V input voltage. DO NOT use the booster with a higher voltage power supply. This can damage the booster, cause personal injury and void your warranty.

Booster Hardware

The following image shows the key hardware components on the cellular booster. Refer to this image as you install your Fusion7 kit components.

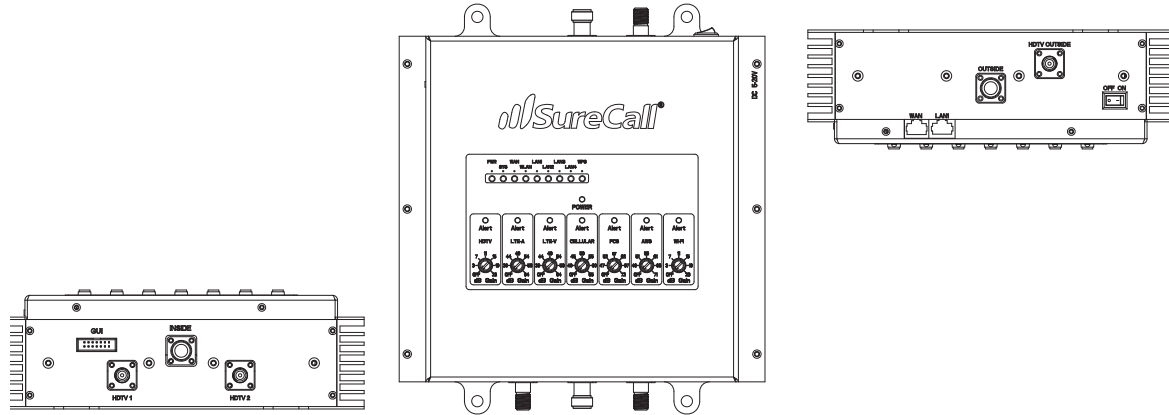

Configure Gain Settings

To begin set the attenuation knobs to maximum gain:

- HDTV: 23 dB
- LTE A and LTE V: 64 dB
- Cellular: 65 dB
- PCS: 72 dB
- AWS: 71 dB
- Wi-Fi: 23 dB

If any of the LEDs alternately blink red and yellow first try adding additional separation between the inside and outside antennas. If after 10 seconds, the light continue to blink red/yellow, lower the attenuation of the affected band in small increments until it stops For more information, refer to “Troubleshooting” on page 16.

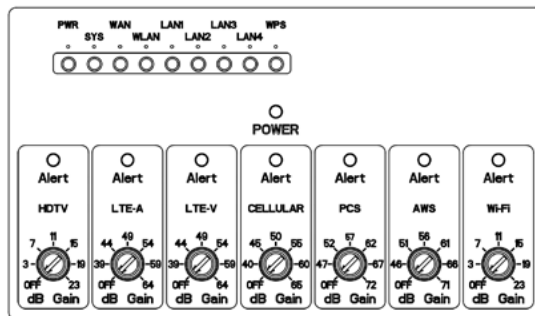

If you Want to Improve Cellular Coverage

1. Find a location that receives a stronger signal and relocate the outdoor antenna to that location.
2. Increase the distance between the outdoor and indoor antennas.
3. Be sure your signal booster’s dB gain is turned up to maximum gain on each dial.

WARNING: Do not adjust the uplink and downlink dB attenuation settings more than 25 dB. This could cause the affected band to shut down

SECTION 2: WI-FI CONNECTION

Installation Instructions:

Before beginning this part of the installation, turn the booster’s power switch off.

1. Connect your router to WAN port on the booster using an Ethernet cable.
2. Power on the booster. The WAN and WLAN lights on the Fusion7 status LEDs will light up.
3. On your Wi-Fi device, search available wireless networks and choose 11n AP, a security password isn’t needed.
4. Create a Secure Password:
 - Connect your LAN cable from the router to the PC.
 - Enter this default IP address: 192.168.2.1 in your web browser. You will be connected to the Fusion7’s configuration page.
 - Go to the Wireless section on the left side of the screen.
 - Go to security link and choose the type of encryption you wish to use. WPA-Mixed is recommended for strongest encryption.
 - Enter a new password in the Pre-Shared/Encryption key window.
 - Apply your settings and you will be prompted to reboot.

Note: To access advanced settings for the internal router, contact SureCall at: 888-365-6283 and we will send you the complete user manual for the router.

SECTION 3: HDTV INSTALLATION

HDTV Installation Instructions (These parts are available as accessories and not included in your kit):

Before beginning this part of the installation, turn the booster’s power switch off.

1. Mount your chosen HDTV antenna (either SC-305W-H or SC-306W-H) in a location appropriate for the chosen antenna.
2. Connect the HDTV antenna to the booster port labeled HDTV OUTSIDE using RG6 cable.
3. Booster ports on the other end labeled HDTV1 and HDTV2 are used to connect the booster directly to your HDTV device(s) using RG6 cable or up to 25 devices using cable splitters.
4. Turn the booster’s power switch on.

Scanning Local Television Channels.

1. On your TV's remote control, press the Input or Source button. From there, you'll select "TV" or "Air". Consult your TV manual for detailed instructions.
2. After selecting "Antenna" or "Air" press the menu button. Choose the antenna option followed by Auto Program.
3. You may then need to select the Air button where you can start searching for local channels.
4. The TV will automatically search all available stations. Once the scan is complete, you can exit your TV menu and begin watching free, high-definition television

Troubleshooting

In the event you encounter a problem, follow the suggestions below to resolve the issue.

Problem	Resolution
Signal booster has no power	<p>Verify that the booster switch is turned on.</p> <p>Connect the power supply to an alternate power source.</p> <p>Be sure the power source is not controlled by a switch that can remove power from the outlet.</p> <p>Check the green POWER LED on the signal booster. If it is OFF, return the power supply to SureCall. Contact tech support at to receive an RMA at: 1-888-365-6283 or support@surecall.com, or go to www.surecall.com 7:00 am – 5:00 pm PST, Monday – Friday to chat with a representative.</p>
After installing your signal booster system, you have no signal or reception	<p>Check the strength of the outdoor signal as close as you can to the outdoor antenna (see instructions on page 8).</p> <p>Verify that all cable connections are tightly fitted to the booster and antenna.</p> <p>ⓘ Remember: Bars are not always a reliable measure of signal. The best way to confirm signal coverage is the ability to place and hold a call.</p>
Your signal booster restarted and shut down for 15 minutes, and is now shut down permanently	<p>Each SureCall signal booster is equipped with Auto Shutdown to prevent cell tower interference. The outdoor antenna may be receiving too much signal from the cell tower.</p> <p>Try moving the antenna to a location that provides more separation from the cell tower. If adequate separation is not possible, try lowering the elevation of the antenna to decrease the signal from the tower.</p>

LED Indicators

Please note the following information:

- As highlighted in the table below, all of the following conditions indicate normal operation: lights off, flashing yellow, or solid yellow.
- The booster gain dials or switches should always be at maximum level unless the control light for a specific

frequency band is flashing red or flashing red-yellow. In either case, only reduce gain via dials or switches if other recommended actions do not resolve the issue.

- It is best to avoid turning the gain dial below 40 dB or, for products that use switches, exceed 25 dB of attenuation as this could cause affected frequency band to stop amplifying.

LED Color	LED Condition	Indication
Yellow	Solid	Indicates that the frequency band is not being used. After a period of time, if there's no activity, that band will go into sleep mode. Light is off while band is active. This is part of normal operation.
Yellow	Flashing	Indicates that the Automatic Gain Control (AGC) is self-adjusting. This is part of normal operation.
Red	Flashing	<p>Indicates that the booster is receiving too much signal which could cause the affected band to automatically turn off. When this happens:</p> <ol style="list-style-type: none"> 1. For kits using an OMNI outside antenna, relocate the outside antenna to a location where the signal is weaker. 2. For kits using a DIRECTIONAL outside antenna, turn the antenna in short increments away from the signal source. 3. Add an inline attenuator to the cable coming into the outside port of the booster. 4. Though not desirable as amplification will not be optimum, lower the dB gain setting in small increments until the light turns off or flashes yellow.
Red	Solid	<p>The frequency band is off.</p> <p>If a red light has been flashing for an extended time due to too much signal, that frequency band will display a solid red light indicating that the circuitry for that frequency band has been turned off.</p> <p>This can also happen when the gain dial for a frequency band has been turned all the way down or, for products that use switches, attenuation greater than 25 dB has been made.</p>
Red/Yellow	Alternately Flashing	Indoor and outdoor antennas may be too close together for proper operation. Increased separation is needed.

Specifications

Fusion7 Specifications	
Uplink Frequency Range (MHz):	698-716 / 776-787 / 824-849 / 1850-1915 / 1710-1755 (G Block Included)
Downlink Frequency Range (MHz):	728-746 / 746-757 / 869-894 / 1930-1995 / 2110-2155 (G Block Included)
Input Impedance:	50 Ω / 75 Ω (HDTV)
Maximum Gain:	Cellular 72 dB / Wi-Fi 23 dB / HDTV 23 dB
Noise Figure:	8 dB
Supported Standards:	CDMA, WCDMA, GSM, EDGE, HSPA+, EVDO, LTE and all cellular standards
VSWR:	≤2.0
Wi-Fi Frequency Range:	2.4 - 2.4835 GHz
Wi-Fi Standards:	IEEE 802.11b, IEEE 802.11g, IEEE 802.11n
Maximum Wi-Fi Wireless Data Rate:	150 Mbps (2.4 GHz)
HDTV Frequency Receive Range (MHz):	54-72 / 76-88 / 174-216 / 470-608 / 614-698
AC Input:	Input AC 110 V, 60 Hz / Output DC 5-20 V
Maximum Output Power:	1 Watt EIRP
Cable:	SC-400 / RG6 (RG6 not included)
RF Connectors:	RP-TNC / N Female
Power Consumption:	<50W
Operation Temperature:	-4° F to +158° F
Dimensions:	10 x 9.5 x 2.75 inches
Weight:	9.0625 lbs
FCC:	RSNFUSION-7

Kitting Information

Component	Product Number: Description	Gain / Loss			
		LTE-A (Verizon & AT&T) 700 MHz	Cellular 800 MHz	PCS 1900 MHz	AWS 1700 / 2100 MHz
Outdoor Antenna	SC-288W: Omni	3 dBi	3 dBi	4 dBi	4 dBi
Outdoor Cable	SC-001-75: SC-400, 75 ft., NN	-4.22 dB	-4.41 dB	-6.17 dB	-6.54 dB
Indoor Cable	SC-001-75-TNC: SC-400, 75 ft., TNC-Male	-4.22 dB	-4.41 dB	-6.17 dB	-6.54 dB
	SC-001-30-TNC: SC-400, 30 ft., TNC-Male	-2.05 dB	-2.12 dB	-2.83 dB	-2.98 dB
Indoor Antenna	SC-222W-RP-TNC: Dome	3 dBi	3 dBi	6 dBi	6 dBi
	SC-248W-RP-TNC: Panel	7 dBi	7 dBi	10 dBi	10 dBi

*All equivalent antennas and cables are suitable for use with the Fusion7 booster.

Note: Due to the recent change of our company name from Cellphone-Mate (CM) to SureCall (SC) we have changed the prefix on all of our antennas, cables and accessories from CM to SC-.

Three-Year Product Warranty

Register at www.SureCall.com

SureCall warrants its products for three years from the date of purchase against defects in workmanship and/or materials. Specifications are subject to change. The three-year warranty only applies to products meeting the latest FCC Certification Guidelines stated on 2/20/2013 and going into effect April 30, 2014. A two-year warranty applies to any products manufactured before May 1, 2014.

Products returned by customers must be in their original, un-modified condition, shipped in the original or protective packaging with proof-of-purchase documentation enclosed, and a Return Merchandise Authorization (RMA) number printed clearly on the outside of the shipping container.

Buyers may obtain an RMA number for warranty returns by calling the SureCall Return Department toll-free at 1-888-365-6283. Any returns received by SureCall without an RMA number clearly printed on the outside of the shipping container will be returned to sender. In order to receive full credit for signal boosters, all accessories originally included in the signal booster box must be returned with the signal booster. (The Buyer does not need to include accessories sold in addition to the signal booster, such as antennas or cables.)

This warranty does not apply to any product determined by SureCall to have been subjected to misuse, abuse, neglect, or mishandling that alters or damages the product's physical or electronic properties.

SureCall warrants to the Buyer that each of its products, when shipped, will be free from defects in material and workmanship, and will perform in full accordance with applicable specifications. The limit of liability under this warranty is, at SureCall's option, to repair or replace any product or part thereof which was purchased up to THREE YEARS after May 1, 2014 or TWO YEARS for products purchased before May 1, 2014, as determined by examination by SureCall, prove defective in material and/or workmanship. Warranty returns must first be authorized in writing by SureCall. Disassembly of any SureCall product by anyone other than an authorized representative of SureCall voids this warranty in its entirety. SureCall reserves the right to make changes in any of its products without incurring any obligation to make the same changes on previously delivered products.

As a condition to the warranties provided for herein, the Buyer will prepay the shipping charges for all products returned to SureCall for repair, and SureCall will pay the return shipping with the exception of products returned from outside the United States, in which case the Buyer will pay the shipping charges.

The Buyer will pay the cost of inspecting and testing any goods returned under the warranty or otherwise, which are found to meet the applicable specifications or which are not defective or not covered by this warranty.

Products sold by SureCall shall not be considered defective or non-conforming to the Buyer's order if they satisfactorily fulfill the performance requirements that were published in the product specification literature, or in accordance with samples provided by SureCall. This warranty shall not apply to any products or parts thereof which have been subject to accident, negligence, alteration, abuse, or misuse. SureCall makes no warranty whatsoever in respect to accessories or parts not supplied by it.

Limitations of Warranty, Damages and Liability:

EXCEPT AS EXPRESSLY SET FORTH HEREIN, THERE ARE NO WARRANTIES, CONDITIONS, GUARANTEES, OR REPRESENTATIONS AS TO MERCHANTABILITY, FITNESS FOR A PARTICULAR PURPOSE, OR OTHER WARRANTIES, CONDITIONS, GUARANTEES, OR REPRESENTATIONS, WHETHER EXPRESSED OR IMPLIED, IN LAW OR IN FACT, ORAL OR IN WRITING.

SURECALL AGGREGATE LIABILITY IN DAMAGES OR OTHERWISE SHALL NOT EXCEED THE PAYMENT, IF ANY, RECEIVED BY CELLPHONE-MATE, INC. FOR THE UNIT OF PRODUCT OR SERVICE FURNISHED OR TO BE FURNISHED, AS THE CASE MAY BE, WHICH IS THE SUBJECT OF CLAIM OR DISPUTE. IN NO EVENT SHALL SURECALL BE LIABLE FOR INCIDENTAL, CONSEQUENTIAL, OR SPECIAL DAMAGES, HOWSOEVER CAUSED.

All matters regarding this warranty shall be interpreted in accordance with the laws of the State of California, and any controversy that cannot be settled directly shall be settled by arbitration in California in accordance with the rules then prevailing of the American Arbitration Association, and judgment upon the award rendered may be entered in any court having jurisdiction thereof. If one or more provisions provided herein are held to be invalid or unenforceable under applicable law, then such provision shall be ineffective and excluded to the extent of such invalidity or unenforceability without affecting in any way the remaining provisions hereof.

FCC, IC and Safety Information

SureCall has made a good faith effort to ensure the accuracy of the information in this document and disclaims the implied warranties of merchantability and fitness for a particular purpose and makes no express warranties, except as may be stated in its written agreement with and for its customers. SureCall shall not be held liable to anyone for any indirect, special or consequential damages due to omissions or errors. The information and specifications in this document are subject to change without notice. © 2016. All Rights Reserved. All trademarks

and registered trademarks are the property of their respective owners.

48346 Milmont Drive
Fremont, California 94538, USA
888.365.6283
www.surecall.com

Important: Before installing your booster you need to register it with your carrier. You can do so online at the following urls:

Verizon: <http://www.verizonwireless.com/wcms/consumer/register-signal-booster.html>

AT&T: <https://securec45.securewebsession.com/attsignalbooster.com/>

T-Mobile: <https://www.signalboosterregistration.com/>

Sprint: https://www.sprint.com/legal/fcc_boosters.html

U.S. Cellular: <http://www.uscellular.com/uscellular/support/fcc-booster-registration.jsp>

FCC Information:

This is a CONSUMER device.

BEFORE USE, you MUST REGISTER THIS DEVICE with your wireless provider and have your provider's consent. Most wireless providers consent to the use of signal boosters. Some providers may not consent to the use of this device on their network. If you are unsure, contact your provider.

You MUST operate this device with approved antennas and cables as specified by the manufacturer. Antennas MUST be installed at least 20 cm (8 inches) from any person. You MUST cease operating this device immediately if requested by the FCC or a licensed wireless service provider.

This device may be operated ONLY in a fixed location for in-building use.

WARNING: E911 location information may not be provided or may be inaccurate for calls served BY USING THIS DEVICE.

Note: This equipment has been tested and found to comply with the limits for a Class B digital device, pursuant to part 15 of the FCC Rules. These limits are designed to provide reasonable protection against harmful interference in a residential installation. This equipment generates, uses and can radiate radio frequency energy and, if not installed and used in accordance with the instructions, may cause harmful interference to radio communications. However, there is no guarantee that interference will not occur in a particular installation. If this equipment does cause harmful interference to radio or television reception, which can be determined by turning the equipment off and on, the user is encouraged to try to correct the interference by one or more of the following measures:

- Reorient or relocate the receiving antenna
- Increase the separation between the equipment and receiver.
- Connect the equipment into an outlet on a circuit different from that to which the receiver is connected
- Consult the dealer or an experienced radio/TV technician for help.

Industry Canada:

This Class A digital apparatus meets all requirements of the Canadian Interference Causing Equipment Regulations. Operation is subject to the following two conditions: (1) this device may not cause harmful interference, and (2) this device must accept any interference received, including interference that may cause undesired operation

Cet appareillage numérique de la classe A répond à toutes les exigences de l'interférence canadienne causant des réglemets d'équipement. L'opération est sujette aux deux conditions suivantes: (1) ce dispositif peut ne pas causer l'interférence nocive, et (2) ce dispositif doit accepter n'importe quelle interférence reçue, y compris l'interférence qui peut causer l'opération peu désirée.

The Manufacturer's rated output power of this equipment is for single carrier operation. For situations when multiple carrier signals are present, the rating would have to be reduced by 3.5 dB, especially where the output signal is re-radiated and can cause interference to adjacent band users. This power reduction is to be by means of input power or gain reduction and not by an attenuator at the output of the device.

La puissance de sortie nominale indiquée par le fabricant pour cet appareil concerne son fonctionnement avec porteuse unique. Pour des appareils avec porteuses multiples, on doit réduire la valeur nominale de 3,5 dB, surtout si le signal de sortie est retransmis et qu'il peut causer du brouillage aux utilisateurs de bandes adjacentes. Une telle réduction doit porter sur la puissance d'entrée ou sur le gain, et ne doit pas se faire au moyen d'un atténuateur raccordé à la sortie du dispositif

This is a **CONSUMER** device.

BEFORE USE, you MUST REGISTER THIS DEVICE with your wireless provider and have your provider's consent. Most wireless providers consent to the use of signal boosters. Some providers may not consent to the use of this device on their network. If you are unsure, contact your provider.

You **MUST** operate this device with approved antennas and cables as specified by the manufacturer. Antennas **MUST** be installed at least 20 cm (8 inches) from any person. You **MUST** cease operating this device immediately if requested by the FCC or a licensed wireless service provider.

WARNING. E911 location information may not be provided or may be inaccurate for calls served by using this device. This device may be operated **ONLY** in a fixed location for in-building use.

Note: This equipment has been tested and found to comply with the limits for a Class B digital device, pursuant to part 15 of the FCC Rules. These limits are designed to provide reasonable protection against harmful interference in a residential installation. This equipment generates, uses and can radiate radio frequency energy and, if not installed and used in accordance with the instructions, may cause harmful interference to radio communications. However, there is no guarantee that interference will not occur in a particular installation. If this equipment does cause harmful interference to radio or television reception, which can be determined by turning the equipment off and on, the user is encouraged to try to correct the interference by one or more of the following measures:

- Reorient or relocate the receiving antenna.
- Increase the separation between the equipment and receiver.
- Connect the equipment into an outlet on a circuit different from that to which the receiver is connected.
- Consult the dealer or an experienced radio/TV technician for help.

FCC 27.50(d)(4) Statement: Fixed, mobile and portable (hand-held) stations operating in the 1720-1755 MHz band are limited 1 Watt EIRP. Fixed stations operating in this band are limited to a maximum antenna height of 10 meters above ground. Mobile and portable stations operating in this band must employ a means for limiting power to the minimum necessary for successful communications.