



FLARE[®] 3.0

5G/LTE Cellular Signal Booster Kit With Integrated Inside Antenna and Bluetooth Installation App for Home & Office



Thank you for purchasing SureCall's Flare 3.0 cellular signal booster kit. The Flare 3.0 was specifically designed to eliminate frustrations over dropped calls and limited range by amplifying incoming and outgoing 5G/LTE cellular signals in homes and offices.

If you have any questions during setup, please reach out to our US-based experienced support technicians:

Call: 1-888-365-6283

Email: support@surecall.com

Or, visit: www.surecall.com/support



Watch installation,
optimization and
troubleshooting
techniques



@SureCall



Stay up to date
with all things
SureCall

TABLE OF CONTENTS

OVERVIEW.....	4
Why indoor signal can be weak	4
How it works	4
Package Contents.....	5
Optional accessories	5
SureCall easy install Bluetooth app.....	6
Getting to know the SureCall app.....	6
BEFORE INSTALLATION.....	7
Important. Before you begin.....	7
Taking signal measurements with your phone	8
Finding your closest cell tower.....	9
Tools needed	11
Grounding the outside antenna	11
Power requirements.....	11
Cable guidelines	11
Routing cable.....	11
INSTALLATION.....	12
Perform a soft install.....	12
Step 1: Find area outside with strongest signal.....	13
Step 2: Install the outside antenna	14
Step 3. Place the booster	15
Step 4: Finalize component placement and cable.....	15
SYSTEM OPTIMIZATION.....	16
Antenna optimization	16
Antenna testing.....	16
LED INDICATORS.....	17
TROUBLESHOOTING	18
SPECIFICATIONS	18
Kitting Information.....	19
CONSUMER GUIDELINES	20
WARRANTY	21
Three-year product warranty	21

OVERVIEW

Why indoor signal can be weak

There are several obstacles that can contribute to the poor reception you receive in your home:

- Distance to your carrier's cell phone tower
- Obstructions caused by terrain and foliage
- Building materials like low-E glass, metal and concrete

How it works

1. The outside antenna collects signal from the cell tower.
2. The outside antenna sends the signal to the booster through coax cable to the booster.
3. The booster amplifies the cell signal and rebroadcasts the signal indoors to all mobile devices within range.
4. The booster amplifies outgoing cell signal back to the tower.

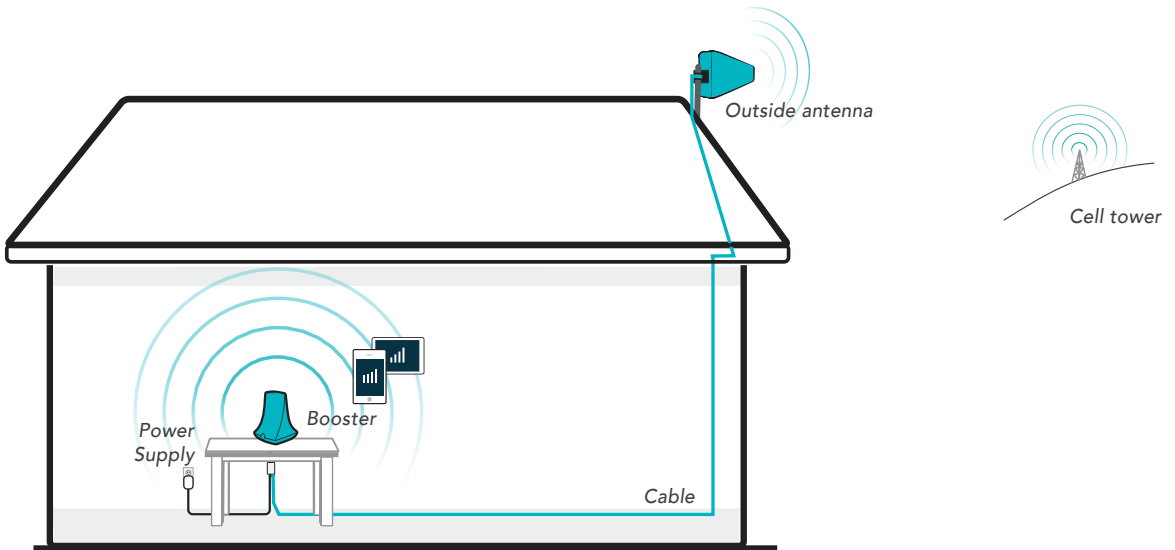

How the SureCall Flare 3.0 Booster Works

Package Contents

Unpack all package contents. For missing or damaged items, contact your reseller. Turn over the signal booster and record the model and serial number for reference:

Serial #: _____

Purchase Date: _____

Keep the carton and packing material to store the product in case you need to return. Your Flare 3.0 signal booster package includes the following items:

1. SureCall Flare 3.0 signal booster
2. Power supply
3. Cable for connecting the outside antenna to the signal booster
4. Outside Yagi antenna

1 Flare 3.0 Cellular Booster **2** Power Supply **3** Indoor Cable (50 ft.) **4** Outside Yagi Antenna



Optional accessories

Looking to upgrade your SureCall booster? Boost your signal even further with these bestselling accessories:



SC-LP-75

Lightning arrestor prevents damage from electrical surges



SC-MOUNT-JBAR

Adjustable 20-inch mounting pole for outdoor antenna



SC-RG11-100

100 ft of RG-11 cable

* Note: Longer cable is helpful only if it allows the outside antenna to be placed where a stronger signal is measured.

WARNING: Any product modifications that use unauthorized antennas, cables, and/or coupling devices are prohibited by the FCC. Contact FCC for details: 1-888-CALL-FCC. Changes or modifications not expressly approved by SureCall could void the user's authority to operate the equipment.

WARNING: Do not collocate antennas or operate the outdoor antenna with any other antenna or signal booster.

SureCall easy install Bluetooth app

Use the SureCall mobile app to help with two important aspects of your Flare 3.0 signal booster setup; proper aiming of the outside antenna and ensuring adequate separation between outside antenna and inside antenna(s).

Download the SureCall app in the Google Play or Apple's App Store. Just search "SureCall".



Getting to know the SureCall app

Using the app to wirelessly connect to your booster provides you with real-time feedback while positioning both components of your booster system. Once you've downloaded the app and paired it with your booster, you will need to create a 'soft install' (page 12) before utilizing the readings found in your app.

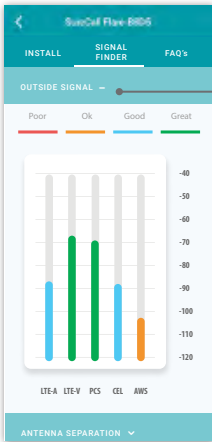

When testing for the best placement and angle for your outside antenna, see "OUTSIDE SIGNAL" tab on the app.



Then get real-time feedback on your booster placement. See "ANTENNA SEPARATION" tab on the app to verify there's enough separation between the components.

BEFORE INSTALLATION

IMPORTANT. BEFORE YOU BEGIN.

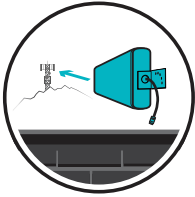

IDENTIFY THE AREA OF STRONGEST OUTSIDE SIGNAL.

Since booster performance is largely determined by the signal strength received by your outside antenna, it is important to identify the location of best signal for placement of your antenna.

The best location is generally found on the side of your home that faces your nearest cell tower and as high as possible -- where the antenna can 'see' your cell tower. Better signal received by your outside antenna means better booster performance inside. Conversely, the weaker your outside signal, the more limited your coverage will be indoors.

If you're unsure of the direction of your carrier's closest cell tower, see page 9 for suggestions.



DO NOT RELY ON CELL PHONE BARS AS AN ACCURATE MEASURING TOOL

Cell phone bars are an approximation of your signal that varies by phone and carrier. Placing your phone in test mode or downloading an app that shows your signal in decibels (dB) is more accurate. For help using this feature on your device, see "Taking signal measurements with your phone" on page 8.

During planning, installation and testing, take multiple readings several minutes apart. Also, verify that you can place and hold a call.



BETTER ANTENNA SEPARATION MEANS BETTER PERFORMANCE

Maintain a distance of at least 25 vertical feet or up to 50 feet of horizontal distance, especially if sufficient vertical separation cannot be achieved. Also, make certain the antennas are aimed away from one another.



Antenna Placement

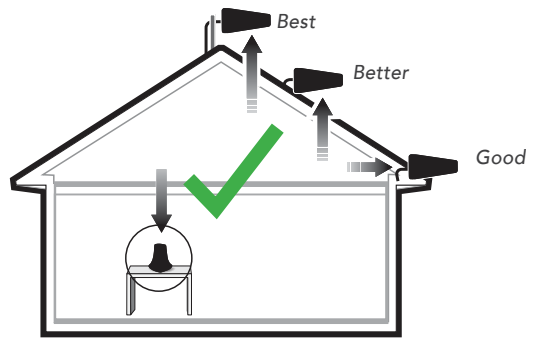

Antenna Aiming

Taking signal measurements with your phone

Cell phone bars are an approximation of your signal that varies by phone and carrier. Viewing measurements in decibel[1] milliwatts provides a more accurate reading. In most cases the units are reported in RSRP (LTE & 5G signals) and will generally fall between -80 dBm (strong) and -130 dBm (very weak). If you are connected over 3G or HSPA the decibels units are reported in RSSI and the units will generally fall between -50 dBm (strong) and -100 dBm (very weak).

PLEASE NOTE, To achieve optimal performance for your booster, it is vital to take care choosing antenna placement and antenna alignment. The coverage area that the booster provides is directly related to the strength of incoming signal received by the outdoor antenna. Mounting the outside antenna where the signal is the strongest provides the best results. If signal is extremely weak where the outside antenna is installed, indoor coverage will be limited.

See the instructions to measure decibels on your phone.

Measuring signal will be helpful to (1) identify the location outside with the strongest signal for placement of your outside antenna and (2) to measure indoor signal strength during installation and testing of your system.

During installation and testing, always take multiple readings several minutes apart. Also, take note of the band number related to each reading for accurate comparisons.

i **NOTE,** signal measurements are displayed alongside their measurement scale. RSRP is one scale commonly used, as is RSSI. For more information, see "Signal measurement scales" on page 9.

FOR IPHONE dBm signal measurements, use the methods below.

1. First turn off your Wi-Fi
2. Dial *3001#12345## then press the call button.
3. The field test screen will appear. Once open, the menu navigation varies depending on the iOS version.
4. Navigate to "Cell Info" in the menu
5. The measurement that reads "RSRP" is your cellular signal strength in decibel-milliwatts.
6. Note Band number

If you're using an earlier version of iOS or looking for more detailed information, we have more instructions available here: www.surecall.com/support

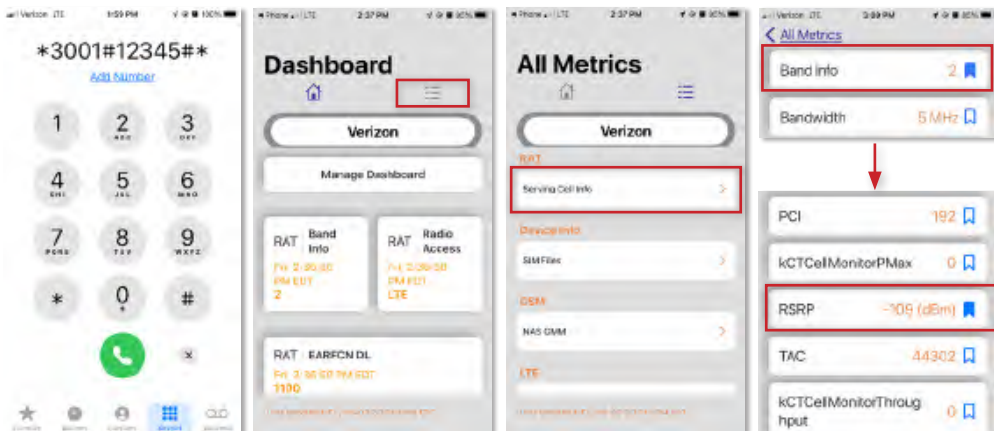

iPhone test mode

FOR ANDROID devices: Download the app “LTE Discovery” in the Google Play store.

1. Note band number
2. LTE/5G (measurement in RSSI or RSRP)



Android app “LTE Discovery”

Signal measurement scales

The relationship between RSRP and RSSI is approximate and depends on the channel bandwidth, noise floor and channel loading. The chart below displays the approximate equivalent of all four measurements:

	Signal Power (dBm)		Signal Quality (dB)	
	RSRP Phone in LTE	RSSI Phone in HSPA	RSRQ Phone in LTE	SINR Phone in HSPA
Very Edge	-125	-102	-25	3
Average	-110	-85	-20	10
Good	-95	-70	-12	15
Best	-80	-55	-8	20

Finding your closest cell tower

Since performance is largely determined by the signal received by the outdoor antenna, it is important to know the direction in which you will aim your directional outside antenna before installation.

The best location for your outside antenna is generally found on the side facing your nearest cell tower and as high as possible -- where the antenna can ‘see’ your cell tower.

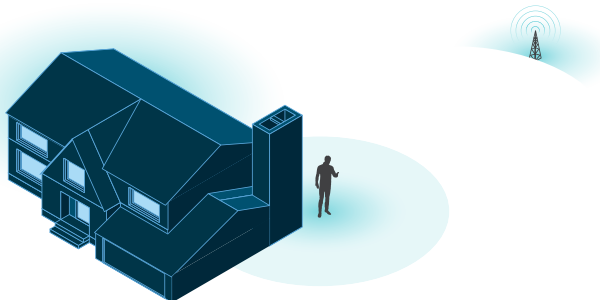

Finding your strongest outside signal

If you're not sure of the location of your nearest cell tower, there are resources available. You may utilize crowd-sourced cell tower resources such as sites like www.cellmapper.net. See below for brief instructions on utilizing cellmapper.net

Visit website www.cellmapper.net

1. Find your location on the map
2. Select your provider

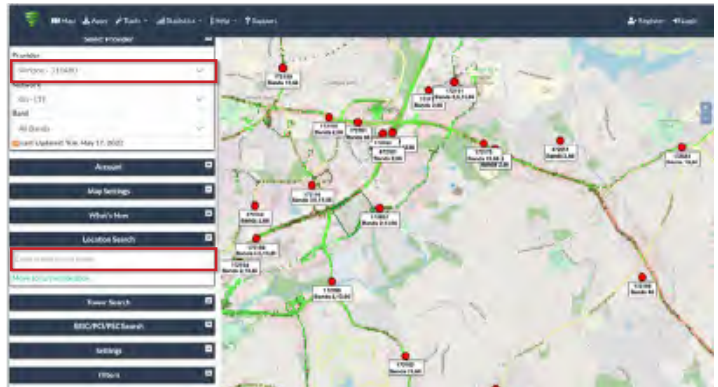

3. Find your cell tower by clicking on the red or green dots on the map closest to your home.

Once selected, detailed information of each base station is shown to the left, including the communication standards and frequency band and block.

The shaded area represents the coverage area for that base station.

4. Locate the closest base station with signal coverage facing the direction of your home and note the direction in relation to your home.

Note: While your home may or may not be located inside a shaded coverage zone indicated on the map.

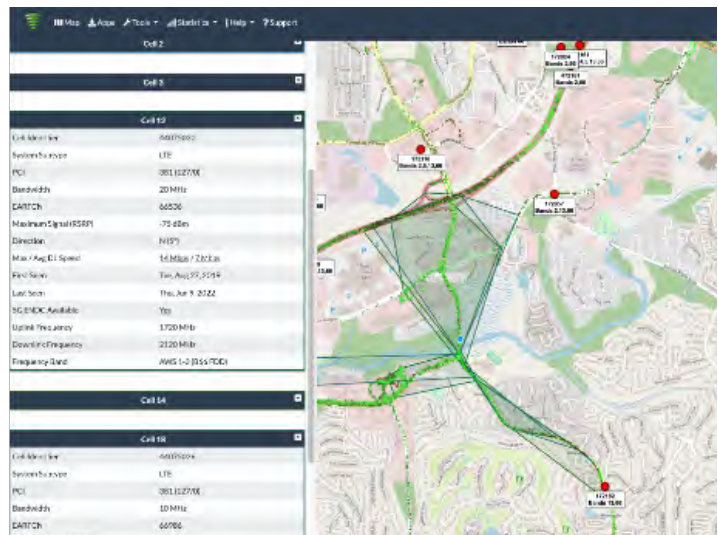

Tools needed

- Ladder
- Drill
- 1-2" diameter pole for mounting outside antenna (if needed, SC-MOUNT-JBAR can be purchased separately)
- Recommended: Surge protected power strip and cable clips.

Grounding the outside antenna

SureCall recommends all outside antennas be properly grounded. See "Optional accessories" on page 5.

Power requirements

Use only the provided power supply with this product (SC-AC-5V-3A-B). DO NOT use the booster with a higher or lower voltage power supply. This can damage the booster, cause personal injury, and void your warranty.

Use of a power strip with surge protection is strongly recommended.

Cable guidelines

The provided cable is 50 ft of RG-6 (part SC-RG6-50). Upgraded cable [part SC-RG11-50 (50 ft)] is available or, if longer cable is needed - 100 ft of RG-11 (part SC-RG11-100) is recommended. A longer cable is helpful only if it allows you to place the outside antenna in a location where you measure stronger signal.

Routing cable

SureCall recommends that cable connected to the outside antenna run straight down and away from the outside antenna, not wrapped or draped near it. When securing the cable, be sure to remove any kinks or loops.

Route cable along and through a wall that leads closest to the location of the booster.

SureCall recommends that cable entering the home from an exterior wall use appropriately rated sealant/caulking at the point of entry.

Following completion of install, weatherproof the exterior coax connections with sealing tape.

INSTALLATION

Before installation, review all the information in this manual.

Perform a soft install

Create a soft installation by positioning the components in their approximate locations. Place the outside Yagi antenna on your roof or wherever you find the best signal. Place the Flare Booster in the center of area where signal is needed and connect the components with the provided cable through an open window.

Once the main components are connected, power up and pair your device with the booster using the SureCall Easy Install Bluetooth app.

Refrain from securing your cable, drilling any holes, etc. until you complete and test the installation of the system.

Once you've identified the optimum angle, secure the outside antenna in place.

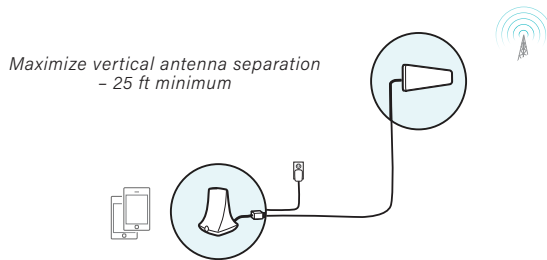

Pairing your device to Bluetooth

- Scan for your Flare 3.0 device by allowing Bluetooth location permissions
- The app will display your device when the unit is in range
- Locate the found device and pair

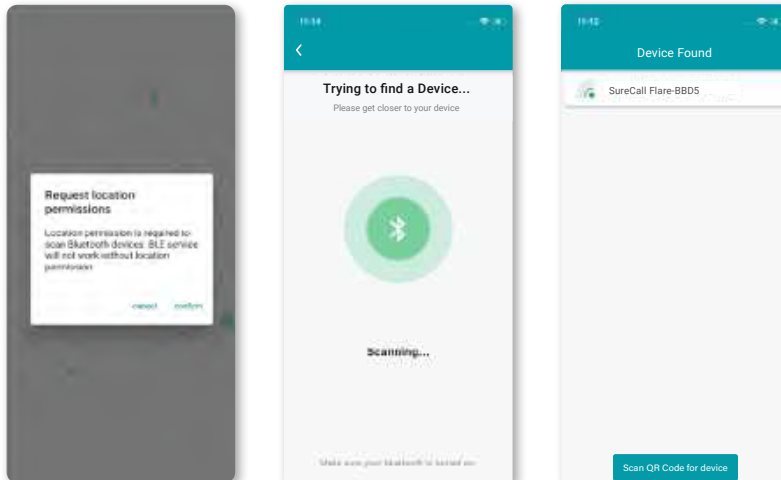

Step 1: Find area outside with strongest signal

Maximum performance is achieved when the antenna is aimed toward the strongest signal source. Use 'OUTSIDE SIGNAL' tab on the app to help as you locate the best outside signal while considering the following:

The best location is generally found above the roof line – as high as possible on the side of your home facing your carrier's nearest cell tower. If you know the direction of your provider's tower, point the antenna in that direction. If you're unsure, use the app while testing various antenna locations. Or see, "Finding your closest cell tower" on page 9.

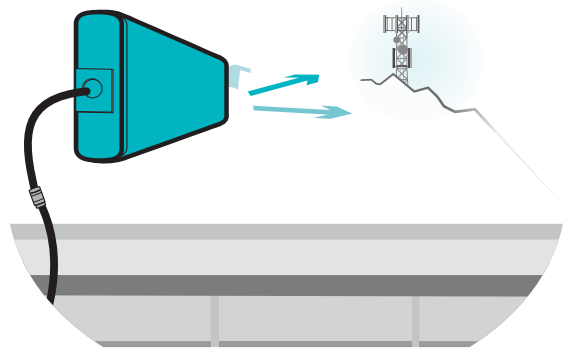

Outside Signal

POOR

Little to no signal detected. You'll need to adjust the placement or angle of your outside antenna.

OK

Weak signal, but good enough sign for minimal results. Move or rotate your outside antenna for better results.

GOOD

Received signal is good. You could install your outside antenna in this area.

GREAT

Received signal is very strong! Install your antenna at this location once your antenna separation measurement is confirmed

Step 2: Install the outside antenna

Once you have identified the area of strongest signal, choose where you will mount your outside antenna while considering the following antenna placement guidelines.

- Mount at the highest possible location above the roofline - The mounting area must have at least a 3 ft radius clear of obstructions, other radiating elements and metal objects such as pipes or metal siding.
- Maximize antenna separation. Plan at least 25 vertical feet (or at least 50 horizontal feet) of separation between the outside antenna the booster.
- Note that the outside antenna can be mounted to an exterior surface or a 1-2 inch diameter pole. A mounting pole is available separately (SC-MOUNT-JBAR) or PVC piping from your local hardware can also be used.
- Avoid placement near windows, where possible, as it increases the potential for oscillation.
- Ensure the outside antenna is oriented to face away from the booster.
- Mount the outside antenna at the corner or side of the roof which faces your cell tower.
- Avoid aiming the antenna towards reflective materials (such as windows) where the signal may be reflected towards your home.

Maximize antenna isolation

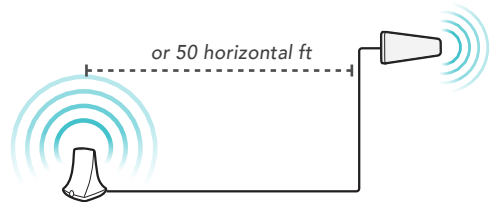
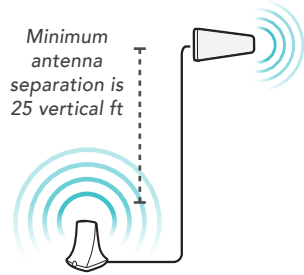

Yagi antenna installation

Assemble the u-bolt, L-bracket, nuts and washers onto a pole (available separately) as shown in the illustration. Orient the antenna with the drip hole at the bottom.

Loosely secure the antenna in a manner that allows for rotation during final system testing.

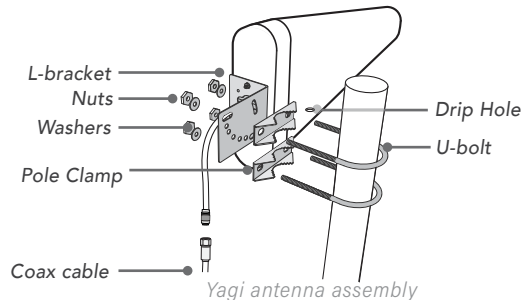

Step 3. Place the booster

Place the Flare signal booster in a central location where cellular reception is needed and close to an AC outlet. When placing the booster, note that further separation between the booster and outside antenna will increase booster performance.

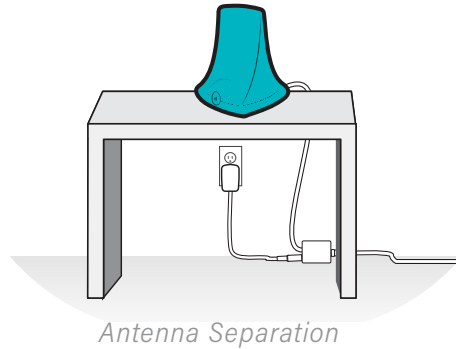

NOTE: Do not apply power until the system is fully connected.

Place the booster where signal is needed and at least 25 vertical feet from the outside antenna, or up to 50 feet horizontally.

Check 'ANTENNA SEPARATION' on the app. The results reflect whether adequate separation between the booster and antenna has been achieved or when insufficient antenna separation is impacting booster coverage.

Sometimes it is not possible to get the full 25 ft of vertical separation. In this situation, try moving the inside and outside antennas around to improve separation without reducing the 'Outside Signal' levels on the app.

Check for sources of interference such as, cellular modems or hotspots near the booster. Ensure a 6 ft radius between the booster and other radiating devices.

Step 4: Finalize component placement and cable

Next, test system performance. Take multiple readings several minutes apart in locations you have previously experienced poor signal. Also, verify you can place and hold a call.

Verify the booster power supply is secure using a standard 110V AC power outlet.

Once installation is optimized for both outside signal and antenna separation, permanently affix cable and components.

Find the cleanest, most efficient route for the cable from the outside antenna to the inside booster.

Secure loose cable. Avoid coiled or kinked cable. Also do not drape cable near the outside antenna.

If cable penetrates an exterior wall, and form a drip loop before building entry and use a permanent sealant to create a moisture barrier.

See "Cable guidelines" on page 11 for more information.

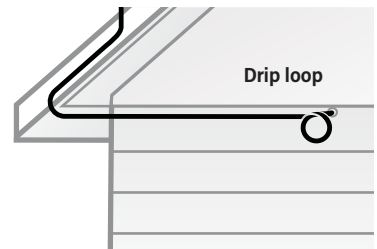

SYSTEM OPTIMIZATION

Antenna optimization

The Flare 3.0 automatically reduces gain (coverage performance) because of insufficient RF separation between the inside and outside antennas. Consider the options listed in this section to resolve issues with inadequate antenna isolation.

Note, in smaller wood constructed homes some reduction in gain is considered 'normal' operation.

- Identify a location outside that receives a stronger signal and move the outside antenna to that location (higher is better).
- Check for sources of interference such as cellular modems or hotspots near the booster. Ensure a 6 ft radius between the booster and other radiating devices.
- Avoid placing either component (booster or outside antenna) near windows as it increases the potential for oscillation.
- Optimize the angle of your outside antenna by testing at small incremental rotations.

Keep in mind, identifying the setup that yields the best possible results for your environment will come from testing – balancing the elimination of interference and while also receiving the best possible signal.

Antenna testing

As a final step, identify the precise antenna angle which provides the maximum possible performance. For this step, it's best to have another person inside to report results. Record your results below.

Rotate the outside antenna around the mast beginning with wide angle measurements then in progressively smaller increments until the peak angle is found. After each turn, power cycle the booster then note the signal reading from the inside antenna's projected area.

Once you've identified the optimum angle, secure the outside antenna in place.

LOCATION	BEFORE	Band #	AFTER, Test 1	Band #	Test 2	Band #	Test 3	Band #

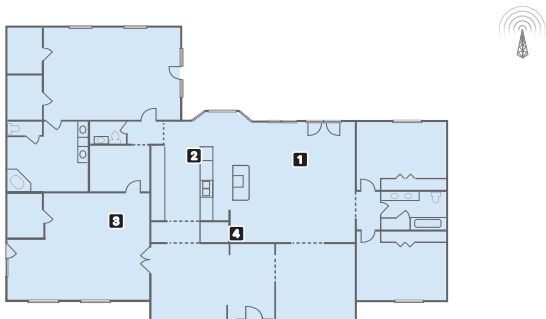

Example testing plan

LED INDICATORS

In addition to the Bluetooth App the booster also has LED indicators.

If an issue is indicated but your signal is improved, it is possible that the frequency band(s) impacted are not used by your carrier and thus, no action is needed.

Note that power cycling the booster after each adjustment may be necessary.

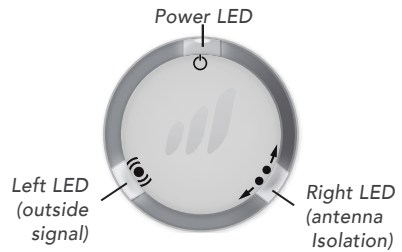

LEFT INDICATOR (Outside Signal)

LED state	Status	Indication
During power up		
Flashing YELLOW/RED	Normal	System test during power on
After power-up		
Solid GREEN	Normal	Normal
Solid RED	Alert - Over signal	Outside signal too strong

Over Signal Alert - The booster is receiving too strong of a signal which may cause one or more of the supported frequency bands to shut off. Unaffected frequency bands will not be impacted, however, and continue to receive enhanced signal.

If this happens but your signal is improved, it's possible that the impacted frequency bands are not used by your carrier and thus, no action is needed.

If this happens and your signal has not improved, consider the following options:

- Relocate the outside antenna where the signal is weaker.
- Adjust the antenna angle by rotating it in small increments away from the cell tower until the LED turns solid GREEN.

RIGHT INDICATOR (Antenna Isolation)

LED state	Status	Indication
During power up		
Flashing YELLOW/RED	Normal	System test during power on
After power-up		
Solid GREEN	Normal	Normal
Solid YELLOW	Reduced gain	Gain is reduced by greater than 8 dB of attenuation. Antenna separation is needed
Solid RED	Alert - Oscillation	Oscillation detected

Reduced Gain - Indicates an adaptive reduction of greater than 8 dB for one or more frequency bands.

If this happens and service quality has not improved, follow suggestions in "Antenna optimization" to improve antenna isolation.

Oscillation Alert - One or more of the supported frequency bands have shut off. Unaffected frequency bands will not be impacted, however, and continue to receive enhanced signal.

If this happens and service quality has not improved, follow suggestions in "Antenna optimization" to improve antenna isolation.

Power cycling the booster after each adjustment may be necessary.

TROUBLESHOOTING

If you have any questions during setup, please reach out to our US-based experienced support technicians:
Call: 1-888-365-6283, Email: support@surecall.com, or Visit: www.surecall.com/support

Problem	Resolution
Signal booster has no power	Connect the power supply to an alternate power source. Be sure the power source is not controlled by a switch that can remove power from the outlet. Check the POWER LED (⏻) on the signal booster. If it is OFF, contact tech support at: 1-888-365-6283 or support@surecall.com , or go to www.surecall.com/support
After installing your signal booster system, you have no signal or reception	Verify that cable connections are tightly fitted to the booster and antenna. Try further separating the booster and antenna. Verify that there is usable signal where the antenna is placed. Remember: Bars are not always a reliable measure of signal. The best way to confirm signal coverage is the ability to place and hold a call.

SPECIFICATIONS

Model	SC-Flare3US
Uplink Frequency Range (MHz):	698-716 / 776-787 / 824-849 / 1850-1915 / 1710-1755
Downlink Frequency Range (MHz):	728-746 / 746-757 / 869-894 / 1930-1995 / 2110-2155
Donor/Server Port Impedance:	75 ohm / 50 ohm
Maximum Gain:	72 dB
Noise Figure:	7 dB
VSWR:	≤2.0
Supported Standards:	5G / 4G / LTE cellular standards
AC Input:	Input: AC 110 - 240 V, 60 Hz ; Output: DC 5V / 3A
Maximum Output Power:	1 Watt EIRP
Cable:	RG6 (50 ft.)
RF Connectors:	Donor port: F Female, Server port: Integral
Power Consumption:	<12W
Weight:	1. 8125 lb.
Dimensions:	5.125 × 7.25 × 5.625 inches
Certifications:	FCC ID: RSNFLARE-3 (Flare 3.0) BLE Module FCC ID: 2ATPO-PB03

Kitting Information

Component	Product number	Gain/Loss					Note
		LTE-A 707 MHz	LTE-V 731 MHz	Cellular 800 MHz	PCS 1900 MHz	AWS 1700 / 2100 MHz	
Outdoor Antenna*	SC-289W	3 dBi	3 dBi	3 dBi	4 dBi	4 dBi / 4 dBi	
	SC-231W	8 dBi	8 dBi	8 dBi	10 dBi	10 dBi / 10 dBi	
Outdoor Cable*	SC-RG6-50	3.32 dB	3.32 dB	3.95 dB	6.42 dB	6.22 dB / 6.68 dB	50 Feet or longer
	SC-RG11-50	2.29 dB	2.29 dB	2.53 dB	3.73 dB	3.68 dB / 4.51 dB	50 feet or longer
Indoor Antenna	SC-322W	2.5 dBi	2.5 dBi	3 dBi	5 dBi	4 dBi / 5 dBi	

*Note: The Flare 3.0 booster is suitable for use with all equivalent and lower gain antennas, as well as, equivalent or greater lengths of cable.

Frequency (MHz)	PreAGC			PreAGC		
	Pulse GSM			4.1 MHz AWGN		
	Input (dBm)	Output (dBm)	Gain (dB)	Input (dBm)	Output (dBm)	Gain (dB)
Uplink: 1710-1755	-49.5	20.0	69.5	-49.0	19.4	68.4
Uplink: 1850-1915	-49.5	22.1	71.6	-45.8	21.6	67.4
Uplink: 824-849	-39.3	25.3	64.5	-36.6	26.0	62.6
Uplink: 698-716	-36.8	25.0	61.8	-37.1	25.2	62.3
Uplink: 777-787	-38.6	22.1	60.7	-38.4	20.5	58.9
Downlink: 2110-2155	-55.2	12.5	67.7	-57.0	10.4	67.4
Downlink: 1930-1995	-57.2	11.2	68.4	-60.4	8.2	68.6
Downlink: 869-894	-51.2	11.8	63.0	-50.8	10.9	61.7
Downlink: 728-746	-47.5	14.5	62.0	-50.7	10.7	61.4
Downlink: 746-757	-45.8	11.8	57.6	-49.4	8.5	57.9

 **NOTE:** Do not apply power until the system is fully connected.

 **WARNING:** This booster should not be used near open fire or flame. Storage and transportation: Store and place in non-extreme room-temperature and dry environment.

 **WARNING:** This booster is rated for 5-15V input voltage. DO NOT use the booster with a higher voltage power supply. This can damage the booster, cause personal injury, and void your warranty.

CONSUMER GUIDELINES

THIS IS A CONSUMER DEVICE

BEFORE USE, you **MUST REGISTER THIS DEVICE** with your wireless provider and have your provider's consent. Most wireless providers consent to the use of signal boosters. Some providers may not consent to the use of this device on their network. If you are unsure, contact your provider.

You **MUST** operate this device with approved antennas and cables as specified by the manufacturer. Antennas **MUST** be installed at least 20 cm (8 inches) from any person. You **MUST** cease operating this device immediately if requested by the FCC or licensed wireless service provider.

WARNING: E911 location information may not be provided or may be inaccurate for calls served by using this device.

This device may operate in a fixed location only, for in-building use.

Register your cellular booster with your wireless carrier at the following urls:

Verizon: <http://www.verizonwireless.com/wcms/consumer/register-signal-booster.html>

AT&T: <https://securec45.securewebsession.com/attsignalbooster.com/>

T-Mobile: <https://support.t-mobile.com/docs/DOC-9827>

Sprint: https://www.sprint.com/legal/fcc_boosters.html

U.S. Cellular: <http://www.uscellular.com/uscellular/support/fcc-booster-registration.jsp>

CAN ICES-3 (B)/NMB-3(B) (Canada) :

This Class B digital apparatus meets all requirements of the Canadian Interference Causing Equipment Regulations. Operation is subject to the following two conditions: (1) this device may not cause harmful interference, and (2) this device must accept any interference received, including interference that may cause undesired operation.

The Manufacturer's rated output power of this equipment is for single carrier operation. For situations when multiple carrier signals are present, the rating would have to be reduced by 3.5 dB, especially where the output signal is re-radiated and can cause interference to adjacent band users. This power reduction is to be by means of input power or gain reduction and not by an attenuator at the output of the device.

This equipment has been tested and found to comply with the limits for a Class B digital device, pursuant to part 15 of the FCC Rules. These limits are designed to provide reasonable protection against harmful interference in a residential installation. This equipment generates, uses and can radiate radio frequency energy and, if not installed and used in accordance with the instructions, may cause harmful interference to radio communications. However, there is no guarantee that interference will not occur in a particular installation. If this equipment does cause harmful interference to radio or television reception, which can be determined by turning the equipment off and on, the user is encouraged to try to correct the interference by one or more of the following measures:

- Reorient or relocate the receiving antenna.
- Increase the separation between the equipment and receiver.
- Connect the equipment into an outlet on a circuit different from that to which the receiver is connected.
- Consult the dealer or an experienced radio/TV technician for help.

Caution: Any changes or modifications not expressly approved by the party responsible for compliance could void the user's authority to operate this equipment.

WARRANTY

Three-year product warranty

To activate your three-year manufacturer's warranty, register at www.SureCall.com/activate

SureCall warrants its products for three years from the date of purchase against defects in workmanship and/or materials. Specifications are subject to change. The three-year warranty only applies to products meeting the latest FCC Certification Guidelines stated on 2/20/2013 and going into effect April 30, 2014. A two-year warranty applies to any products manufactured before May 1, 2014.

Products returned by customers must be in their original, un-modified condition, shipped in the original or protective packaging with proof-of-purchase documentation enclosed, and a Return Merchandise Authorization (RMA) number printed clearly on the outside of the shipping container.

Buyers may obtain an RMA number for warranty returns by calling the SureCall Return Department toll-free at 1-888-365-6283. Any returns received by SureCall without an RMA number clearly printed on the outside of the shipping container will be returned to sender. In order to receive full credit for signal boosters, all accessories originally included in the signal booster box must be returned with the signal booster. (The Buyer does not need to include accessories sold in addition to the signal booster, such as antennas or cables.)

This warranty does not apply to any product determined by SureCall to have been subjected to misuse, abuse, neglect, or mishandling that alters or damages the product's physical or electronic properties.

SureCall warrants to the Buyer that each of its products, when shipped, will be free from defects in material and workmanship, and will perform in full accordance with applicable specifications. The limit of liability under this warranty is, at SureCall's option, to repair or replace any product or part thereof which was purchased up to THREE YEARS after May 1, 2014 or TWO YEARS for products purchased before May 1, 2014, as determined by examination by SureCall, prove defective in material and/or workmanship. Warranty returns must first be authorized in writing by SureCall. Disassembly of any SureCall product by anyone other than an authorized representative of SureCall voids this warranty in its entirety. SureCall reserves the right to make changes in any of its products without incurring any obligation to make the same changes on previously delivered products.

As a condition to the warranties provided for herein, the Buyer will prepay the shipping charges for all products returned to SureCall for repair, and SureCall will pay the return shipping with the exception of products returned from outside the United States, in which case the Buyer will pay the shipping charges.

The Buyer will pay the cost of inspecting and testing any goods returned under the warranty or otherwise, which are found to meet the applicable specifications or which are not defective or not covered by this warranty.

Products sold by SureCall shall not be considered defective or non-conforming to the Buyer's order if they satisfactorily fulfill the performance requirements that were published in the product specification literature, or in accordance with samples provided by SureCall. This warranty shall not apply to any products or parts thereof which have been subject to accident, negligence, alteration, abuse, or misuse. SureCall makes no warranty whatsoever in respect to accessories or parts not supplied by it.

Limitations of Warranty, Damages and Liability:

EXCEPT AS EXPRESSLY SET FORTH HEREIN, THERE ARE NO WARRANTIES, CONDITIONS, GUARANTEES, OR REPRESENTATIONS AS TO MERCHANTABILITY, FITNESS FOR A PARTICULAR PURPOSE, OR OTHER WARRANTIES, CONDITIONS, GUARANTEES, OR REPRESENTATIONS, WHETHER EXPRESSED OR IMPLIED, IN LAW OR IN FACT, ORAL OR IN WRITING.

SURECALL AGGREGATE LIABILITY IN DAMAGES OR OTHERWISE SHALL NOT EXCEED THE PAYMENT, IF ANY, RECEIVED BY CELLPHONE-MATE, INC. FOR THE UNIT OF PRODUCT OR SERVICE FURNISHED OR TO BE FURNISHED, AS THE CASE MAY BE, WHICH IS THE SUBJECT OF CLAIM OR DISPUTE. IN NO EVENT SHALL SURECALL BE LIABLE FOR INCIDENTAL, CONSEQUENTIAL, OR SPECIAL DAMAGES, HOWSOEVER CAUSED.

All matters regarding this warranty shall be interpreted in accordance with the laws of the State of California, and any controversy that cannot be settled directly shall be settled by arbitration in California in accordance with the rules then prevailing of the American Arbitration Association, and judgment upon the award rendered may be entered in any court having jurisdiction thereof. If one or more provisions provided herein are held to be invalid or unenforceable under applicable law, then such provision shall be ineffective and excluded to the extent of such invalidity or unenforceability without affecting in any way the remaining provisions hereof.

SureCall has made a good faith effort to ensure the accuracy of the information in this document and disclaims the implied warranties of merchantability and fitness for a particular purpose and makes no express warranties, except as may be stated in its written agreement with and for its customers. SureCall shall not be held liable to anyone for any indirect, special or consequential damages due to omissions or errors. The information and specifications in this document are subject to change without notice.

© 2025. All Rights Reserved. All trademarks and registered trademarks are the property of their respective owners.

SureCall, Inc
48346 Milmont Drive
Fremont, California 94538, USA
888.365.6283 | www.surecall.com