



Fusion5X™ 2.0

Voice and 4G LTE Signal Booster Kit for Large Buildings

User Guide



Overview

Thank you for purchasing SureCall's Fusion5X 2.0 cellular signal booster kit. Fusion5X 2.0 was specifically designed to eliminate frustrations over dropped calls, limited range and slow data rates by amplifying incoming and outgoing cellular signals in buildings.

The Fusion5X 2.0 provides enhanced cellular signals for multi-carrier voice and 4G LTE data.

If you have any questions during setup, please reach out to our US-based experienced support technicians:

Call: 1-888-365-6283

Email: support@surecall.com

Or, **visit:** www.surecall.com/support



Watch installation, optimization and troubleshooting techniques in our SureCall University YouTube channel



@SureCall



Stay up to date with all things SureCall

TABLE OF CONTENTS

HOW IT WORKS4

PACKAGE CONTENTS.....4

BEFORE INSTALLATION.....7

 Installation Overview 7

INSTALLATION8

 Step 1. Find the area with the Strongest Signal 8

 Step 2. Install the Outdoor Antenna..... 9

 Option A: Outdoor Omni Antenna..... 9

 Option B: Outdoor Yagi Antenna 11

 Step 3. Install Indoor Antenna(s) 12

 Option A: Indoor Dome Antenna(s) 12

 Option B: Indoor Ultra Thin™ Antenna..... 14

 Option C: Indoor Panel Antenna 16

 Step 4. Install the Signal Booster 18

IF YOU WANT TO IMPROVE PERFORMANCE.....19

LED INFORMATION.....20

TROUBLESHOOTING21

SPECIFICATIONS.....22

 Kitting Information 23

WARRANTY24

 Three-Year Product Warranty 24

CONSUMER GUIDELINES.....25

HOW IT WORKS

SureCall's Fusion5X 2.0 is a high-quality bidirectional signal booster that enhances cellular signals to areas that are prone to weak cellular coverage.

Fusion5X 2.0 works with two types of antennas:

- 1 An outdoor antenna that communicates with the cell tower.
- 2 One or more indoor antennas that communicates with your cell phone.

Signals sent from a cell tower are received by the outdoor antenna, amplified by the booster and then sent to your phone via the indoor antenna. When your phone transmits, the signal is sent to the indoor antenna, and then sent to the cell tower via the outdoor antenna.

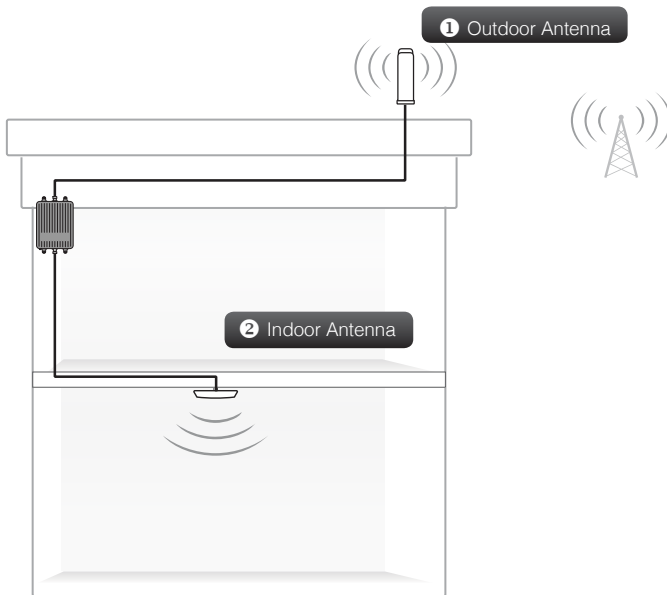

PACKAGE CONTENTS

1. Unpack all package contents. For missing or damaged items, contact your reseller.
2. Turn over the signal booster and record the model and serial number for reference:

Serial #: _____

Purchase Date: _____

Keep the carton and packing material to store the product in case you need to return it.

Fusion5X 2.0 signal booster kits are available with the following:

- One SureCall Fusion5X 2.0 booster with mounting hardware and power supply
- One outdoor antenna (either Omni or Yagi)
- One 75 ft. SC-400 low-loss coax cable to connect outdoor antenna to booster
- One or more indoor antennas (either Dome, Ultra Thin, or Panel)
- One cable per indoor antenna (to connect antennas to signal booster)
- Also included with kits with multiple indoor antennas, one splitter and 30 ft. cable (splitter connects multiple indoor antennas to booster)

Booster



Fusion5X 2.0

Outside Antenna (options)



Omni



Yagi

Outside Cable



75 ft cable–SC-400

Inside Antenna (options)



Dome(s)



Ultra Thin(s)



Panel(s)

Inside Cable (options)

Single Antenna Kits



100 ft cable–SC-400

Multiple Antenna Kits



Splitter + 30 ft SC400







75 ft cable–SC-400

Model number	Model name	Outside Antenna Type	Outside Cable Length	Inside Antenna (Qty)	Inside Antenna Type	Inside Cable (Qty)	Inside Cable Length	Splitter & cable
SC-Fusion5X2-OD	Fusion5X 2.0 Omni/Dome	Omni	75 ft	(1)	Dome	(1)	100 ft	-
SC-Fusion5X2-O4D	Fusion5X 2.0 Omni / 4 Dome	Omni	75 ft	(4)	Dome	(4)	75 ft	1
SC-Fusion5X2-OP	Fusion5X 2.0 Omni/Panel	Omni	75 ft	(1)	Panel	(1)	100 ft	-
SC-Fusion5X2-O4P	Fusion5X 2.0 Omni / 4 Panel	Omni	75 ft	(4)	Panel	(4)	75 ft	1
SC-Fusion5X2-YD	Fusion5X 2.0 Yagi/Dome	Yagi	75 ft	(1)	Dome	(1)	100 ft	-
SC-Fusion5X2-Y4D	Fusion5X 2.0 Yagi / 4 Dome	Yagi	75 ft	(4)	Dome	(4)	75 ft	1
SC-Fusion5X2-YP	Fusion5X 2.0 Yagi/Panel	Yagi	75 ft	(1)	Panel	(1)	100 ft	-
SC-Fusion5X2-Y4P	Fusion5X 2.0 Yagi / 4 Panel	Yagi	75 ft	(4)	Panel	(4)	75 ft	1
SC-Fusion5X2-OU	Fusion5X 2.0 Omni/ Ultra Thin	Omni	75 ft	(1)	Ultra Thin	(1)	100 ft	-
SC-Fusion5X2-O4U	Fusion5X 2.0 Omni / 4 Ultra Thin	Omni	75 ft	(4)	Ultra Thin	(4)	75 ft	1
SC-Fusion5X2-YU	Fusion5X 2.0 Yagi/ Ultra Thin	Yagi	75 ft	(1)	Ultra Thin	(1)	100 ft	-
SC-Fusion5X2-Y4U	Fusion5X 2.0 Yagi / 4 Ultra Thin	Yagi	75 ft	(4)	Ultra Thin	(4)	75 ft	1

Package Contents

Note: Fusion5X 2.0 is available in kits that use the following antenna options based on your particular needs.

	Antenna Type	Model No.	Usage Coverage
Outside Antenna Options			
	Outdoor omnidirectional antenna 2-3 dBi / 3-4 dBi	SC-288W	Omni antennas are the ideal solution for sending/receiving signal from all directions.
	Outdoor directional Yagi antenna 8 dBi	SC-230W	The Yagi antenna is a higher gain solution ideal for low signal locations where the antenna can be aimed to your closest tower.
Inside Antenna Options			
	Indoor omnidirectional dome antenna 2 dBi / 5 dBi	SC-222W	The dome antenna, generally ceiling-mounted, is omnidirectional, sending/receiving signal in all directions indoors.
	Indoor Omnidirectional Ultra Thin™ antenna 3.5 dBi / 7.5 dBi	SC-228W	SureCall's Ultra Thin higher gain ceiling mount antenna is omnidirectional, sending/receiving signal in all directions indoors.
	Indoor directional panel antenna 7 dBi / 10 dBi	SC-248W	The panel antenna, generally wall-mounted, provide directional indoor coverage. H. beamwidth: 120°; V beamwidth: 100°

BEFORE INSTALLATION

- Make sure you have positioned the booster close enough to an existing electrical outlet.
- Make sure you have sufficient cable length between proposed outdoor antenna location and booster connector.
- Make sure you have sufficient separation between outdoor antenna and indoor antennas. At least 75 ft. is recommended for best performance.

Antenna Separation

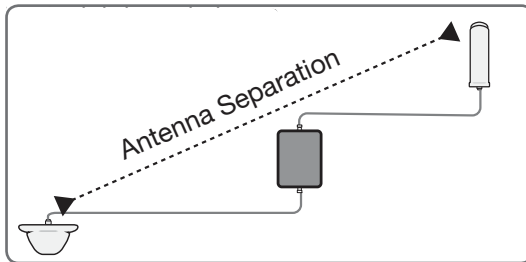

Outdoor/ Indoor Antenna Separation

A minimum of 75 ft. of separation between the outdoor antenna and indoor antennas is recommended for best performance.

Reducing antenna separation will reduce the coverage provided by the booster and generally, additional separation will provide better performance.

- For kits that use directional antennas (outside or inside), the directional antenna(s) should be oriented in a way that they do not "face" the other antenna (see "Antenna Aiming" Diagram).

Antenna Aiming

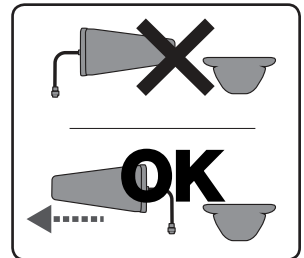

Installation Overview

- Step 1. Find the outside area that has the strongest signal.
- Step 2. Install the outdoor antenna in the area identified in step 1.
- Step 3. Install the indoor antennas where increased signal is needed.
- Step 4. Mount the signal booster, connect the outdoor and indoor antenna cables to the signal booster, and connect the booster to an AC power source.

INSTALLATION

Step 1. Find the area with the Strongest Signal

Using your phone, identify the outside location with the strongest signal for placement of your outside antenna. Generally, this is found above the roofline on the side facing your nearest cell tower and as high as possible – where the antenna can ‘see’ your cell tower. To find the location of your carrier’s closest cell tower, go to www.antennasearch.com.

The coverage area that the booster provides is directly related to the strength of incoming signal received by the outdoor antenna. Mounting the outside antenna where the signal is the strongest will provide the best results. Please note, if signal is extremely weak where the outside antenna is installed, indoor coverage will be limited.

Note that Bars are not always a reliable measure of signal. The best way to confirm signal coverage is the ability to place and hold a call.

Putting your phone in Field Test mode will also indicate what level of decibels (dB) your phone is currently receiving. Decibels are measured in the negatives, and a score closer to zero indicates you have a better signal. A signal of -120 dB indicates you have no service, while a score of about -50 dB means you have excellent signal strength.

For specific dB signal measurements, use the methods below.

- Apple iPhones: Dial *3001#12345#* and press Call. In the top-left corner, a dB number appears instead of bars.
- Android devices: download the app “Network Signal Info” in the Google Play store.
- Internet: Go to: www.speedtest.net to test your 3G and 4G data rates.

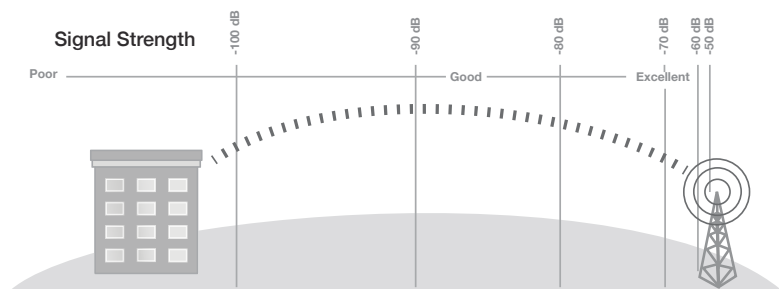

Step 2. Install the Outdoor Antenna

After identifying the area of strongest signal, choose the surface where you will mount your outside antenna.

The location should allow for sufficient separation between the outside antenna and inside antennas. The minimum separating distance recommended for this booster is 75 Ft. Vertical separation is preferred as it is more effective than horizontal separation. See “Antenna Separation” on page 7

Your Fusion5X 2.0 kit comes with one of two available outside antennas

- a. An omni antenna
- b. A directional Yagi antenna

Before proceeding, please note:

For either antenna option, mount the outside antenna in the location identified in step 1 above the roofline and as high as possible. Ensure that the mounting area has at least a 3-ft radius clear of obstructions and other radiating elements.

Always orient directional antennas to point away from other system antennas (see illustration, “Antenna Aiming” on page 7).

IMPORTANT: Do not collocate antennas or operate the outdoor antenna with any other antenna or signal booster.

Option A: Outdoor Omni Antenna

The omni antenna is omni-directional, which receives and sends signals in a 360° radius. The provided hardware allow for either a surface mount or pole-mount. For best performance, be sure to place the outdoor antenna at least 75 feet from the indoor antennas.

Place the antenna as high as possible. Make sure that the mounting area has at least a 36-inch radius clear of obstructions and other radiating elements. The antenna should be mounted in an upright position. See illustration.



Omni antenna with surface mount hardware



Pole-mount hardware

Installation

To mount antenna to a vertical surface:

1. Using vertical plate of L-bracket, mark position of desired placement.
2. Place vertical L-bracket into desired location and tap the screws, head first, along with sleeve, into stucco 1/2 to 5/8 inches deep into place. (Note: Alternate screws may be required for different surfaces such as wood or concrete.)
3. In this order, place washer, lock washer and nut on each screw and tighten until secure. When tightening screw, sleeve will expand to secure plate.
4. Use provided screws to secure antenna base onto horizontal plate.
5. Connect antenna to cable connector for the outdoor cable provided with your kit and run along route to planned location of your booster.

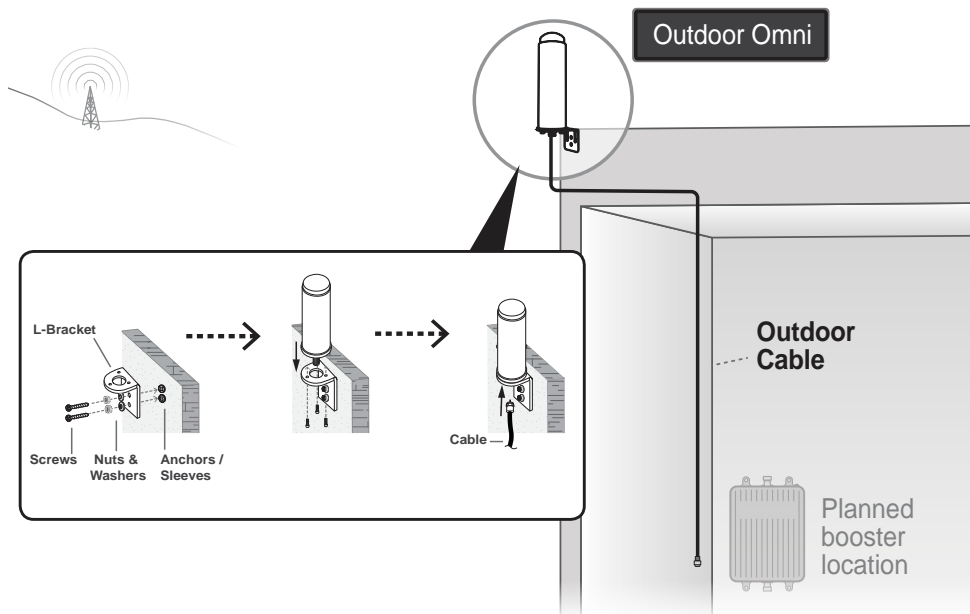

Option B: Outdoor Yagi Antenna

Before installing a Yagi directional antenna, note that the antenna should be mounted on a pole or pipe (not provided), at the highest possible location above the roofline where the antenna can “see” your cell tower. Mount horizontally, aimed in the direction of your nearest cell tower. To find the location of your carrier’s closest cell tower, go to www.antennasearch.com.

Ensure that the mounting area has at least a 3-ft radius clear of obstructions and other radiating elements and orient the antenna with the drip hole at the bottom.

Once you have identified your install location, assemble the u-bolt, bracket, nuts and washers onto a pole or pipe as shown in the illustration. Keep the connections loose enough to allow the antenna to rotate until the optimum direction is found.

Once the outside antenna is secured to a pipe or pole, Connect antenna to cable connector for the outdoor cable provided with your kit and run all route to planned location of your booster.

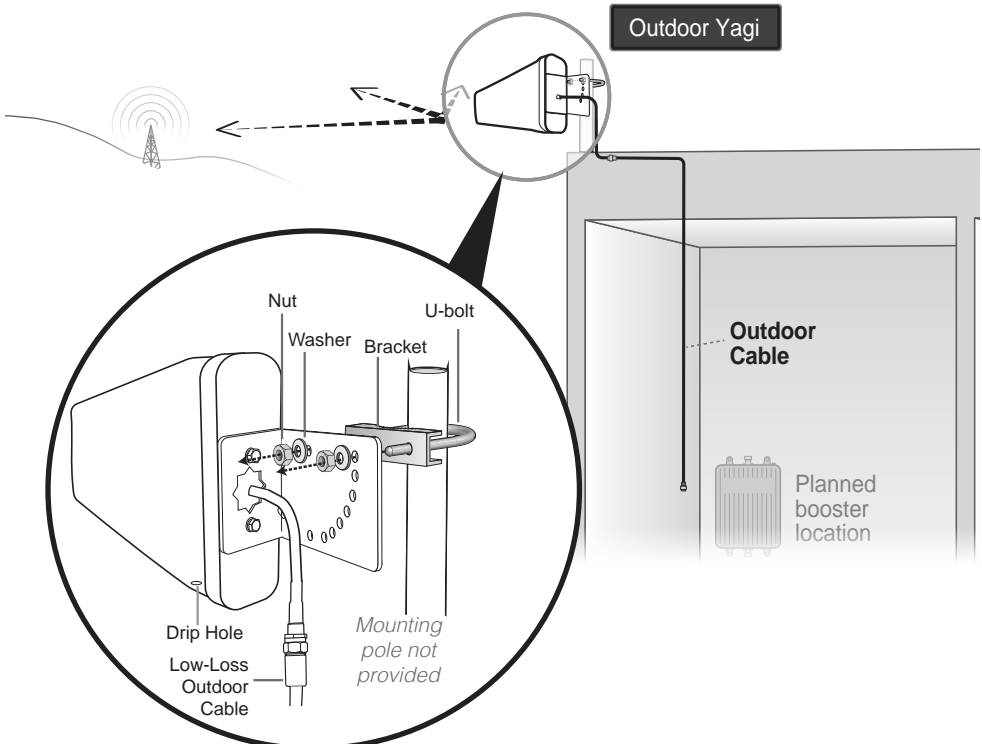

Step 3. Install Indoor Antenna(s)

Indoor antennas for the Fusion5X 2.0 are omni-directional ceiling mount antennas. One indoor cable or pair of cables is provided per antenna. For kits with multiple antennas, a cable splitter and joining 30ft cable is also supplied.

- For indoor dome antennas, mount on a ceiling in a central location where signal is needed.
- For indoor panel antennas, mount on a wall that faces in the direction signal is needed.

Option A: Indoor Dome Antenna(s)

The SC-222W wideband antenna is an omni-directional interior antenna that gathers and sends signals from all sides. Range of antenna is dependent on three factors:

1. Physical obstructions
2. Power generated by booster
3. Signal level received by the outdoor antenna

Besides the antenna itself, parts include mounting equipment. It should be mounted on a ceiling pointed down and in a central location for best results. You can also install your interior antenna above the ceiling panel provided there are not materials that could obstruct signals.

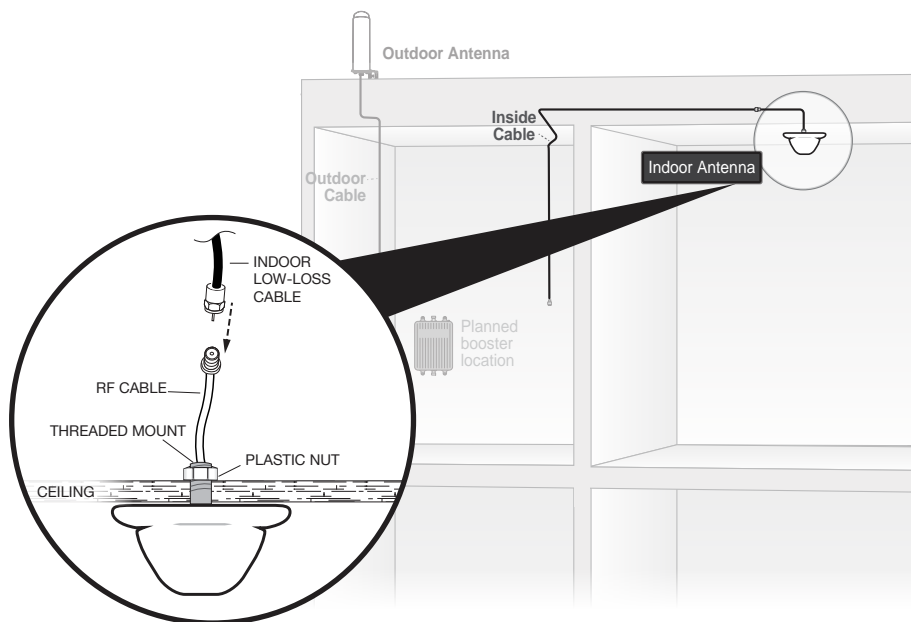

For Each Antenna:

1. Drill a 20 mm diameter hole in the ceiling. The ceiling thickness should be 20 mm, maximum.
2. Unscrew fixing nut from antenna. Place antenna cable through hole. Screw the fixing nut back onto antenna and cable on crawl space side of ceiling and fasten.
3. Tighten fixing nut to secure antenna (do not over-tighten).

For kits with a single indoor antenna:

4. Connect female antenna connector to a the indoor antenna cable provided with your kit and run along route toward the planned location of your booster.

For kits with multiple indoor antennas:

4. Connect each indoor antenna to a the indoor antenna cable provided with your kit and run along route toward the planned location of your booster. Join all cables to provided cable splitter.
5. Connect one end of the 30 ft provided cable to the remaining port of the cable splitter labeled INPUT and route cable to the planned location of your booster.

Note: Be sure to provide enough separation from outdoor antenna (at least 75 ft. is recommended).

Important: Storage and transportation: Store and place in non-extreme room-temperature and dry environment This antenna should not be used near open fire or flame.



Splitter + 30 ft cable
(for multiple antenna kits)

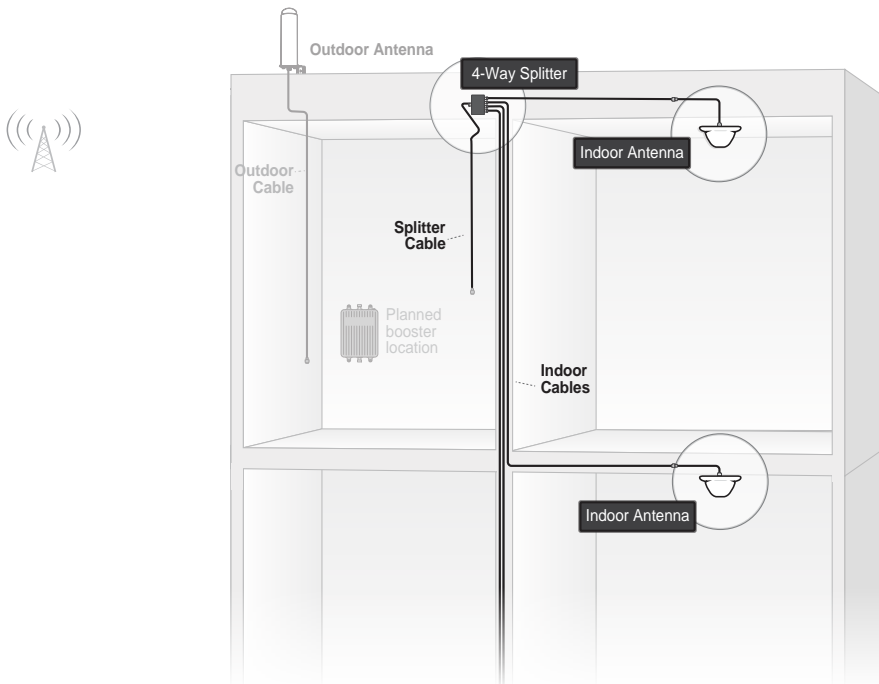

Installation

Option B: Indoor Ultra Thin™ Antenna

The SC-288W wideband antenna is an omni-directional interior antenna that gathers and sends signals from all sides. Besides the antenna itself, parts include mounting options for an install that is accessible by crawl space or one that is not. Optimally, It should be located central to where signal is needed with minimal obstacles.



The range of this antenna is dependent on three factors:

1. Physical obstructions
2. Power generated by booster
3. Signal level received by the outdoor antenna

For Each Antenna:

If accessible by crawl space:

1. Drill a 20 mm diameter hole in the ceiling. The size should be large enough to allow the antenna's plastic cable base to pass through.
2. Place antenna cable through hole.
3. From crawl space, screw the fixing nut onto antenna and fasten around the threaded plastic cable base.

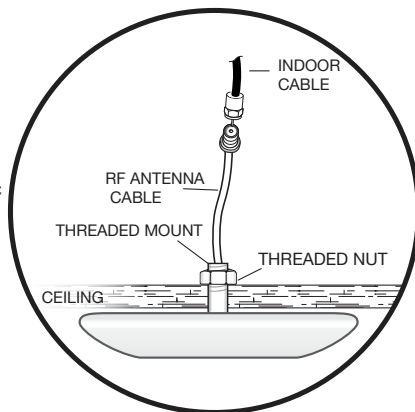

If not accessible by crawl space, a metal bracket mount has been provided along with instructions for this mounting option.

For kits with a single indoor antenna:

4. Connect female antenna connector to a the indoor antenna cabling provided with your kit and run along route toward the planned location of your booster.

For kits with multiple indoor antennas:

1. Connect each indoor antenna to the cable provided with your kit and run along route toward the planned location of your booster. Join all cables to provided cable splitter.
2. Connect one end of the 30 ft provided cable to the remaining port of the cable splitter labeled INPUT and route cable to the planned location of your booster.

Note: Be sure to provide enough separation from outdoor antenna (at least 75 ft. is recommended).

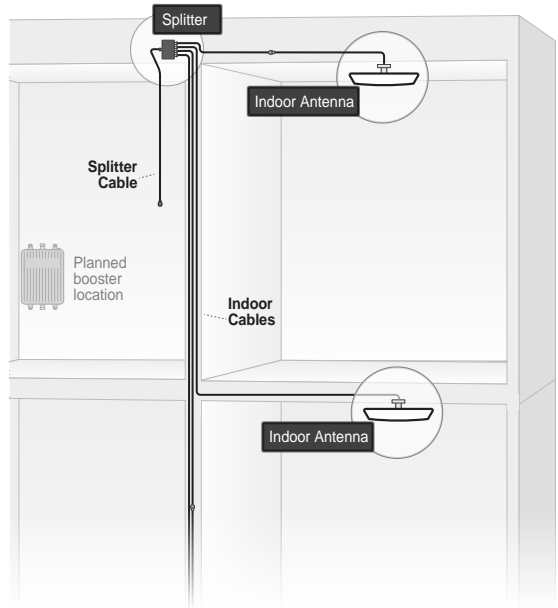

Important: Storage and transportation: Store and place in non-extreme room-temperature and dry environment This antenna should not be used near open fire or flame.

Installation

Option C: Indoor Panel Antenna

The provided panel antennas are multi-band directional antennas with a 120° reach. They should be mounted facing the area signal is needed. It is also important that they do not point toward the outdoor antenna. Range of antenna is dependent on three factors:

1. Physical obstructions
2. Power generated by booster
3. Signal level received by the outdoor antenna

Besides the antenna itself, parts include mounting equipment for a flat horizontal surface. You can also install your interior antenna behind a wall provided there are not materials that could obstruct signals.



For Each Indoor Panel Antenna:

1. Choose location for mounting antenna on vertical surface. Ideal height off the ground or floor should be the approximate height of regular cell phone use.
2. Using plate, mark position of desired screw placement.
3. Screw mounting plate into place with the slide panel protruding towards you.
4. Slide antenna securely onto mounting plate.

For kits with a single indoor antenna:

4. Connect female antenna connector to the indoor antenna cable(s) provided with your kit and run along route toward the planned location of your booster.

For kits with multiple indoor antennas:

5. Connect each indoor antenna to indoor antenna cabling provided with your kit and run along route toward the planned location of your booster. Join all cables to provided cable splitter.
6. Connect one end of the 30 ft provided cable to the remaining port of the cable splitter labeled INPUT and route cable to the planned location of your booster.



*Splitter + 30 ft cable
(for multiple antenna kits)*

Note: Be sure to provide enough separation from outdoor antenna (at least 75 ft. is recommended).

Important: Storage and transportation: Store and place in non-extreme room-temperature and dry environment
This antenna should not be used near open fire or flame.
Fixed stations operating in the 1710-1755 MHz bands are limited to a maximum antenna height of 10 meters above ground.

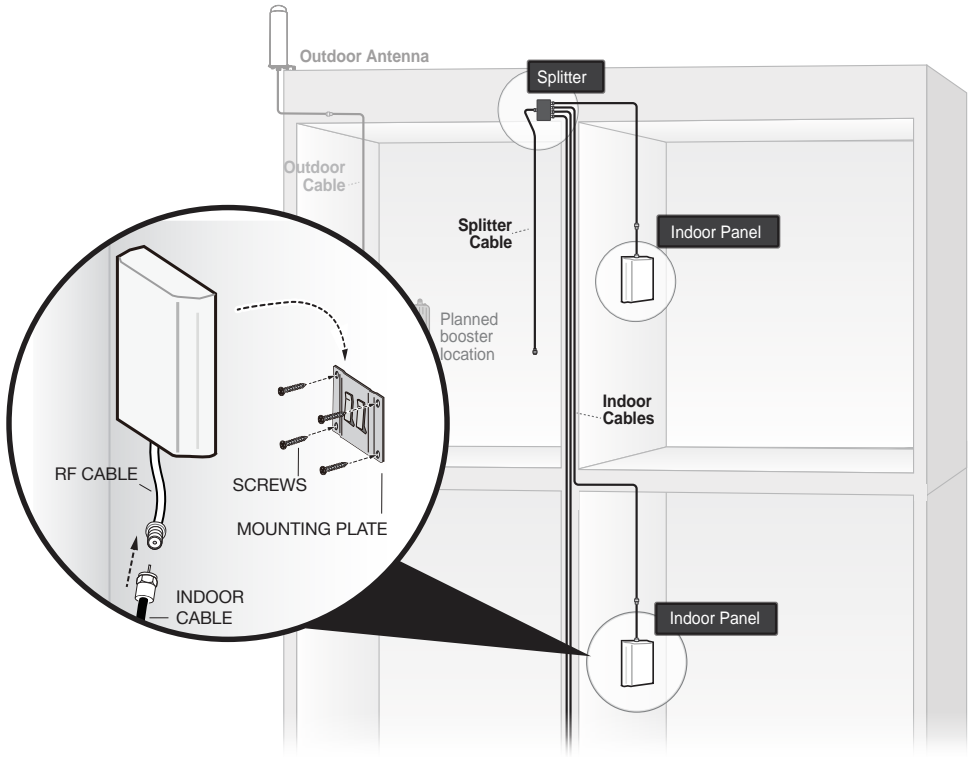

Step 4. Install the Signal Booster

1. When placing the booster, select a location close to a working AC outlet. Do not expose the signal booster to excessive heat, direct sunlight, moisture, and airtight enclosures.
2. If you'd like to mount the booster to a wall, mark location of screw tabs on the wall in the desired location. Use supplied screws or appropriate screws for surface of mounting location and drill through screw tab holes on booster.
3. Connect the outdoor antenna cable to the signal booster connector port marked OUTSIDE and hand-tighten the connection.
4. Connect the cable coming from the indoor antenna or from antenna's cable splitter to the booster port marked INSIDE and hand-tighten the connection.
5. Connect the AC power cord to the signal booster.
6. Connect the plug on the other end of the 110V AC power outlet.
7. Turn the booster's power switch on.

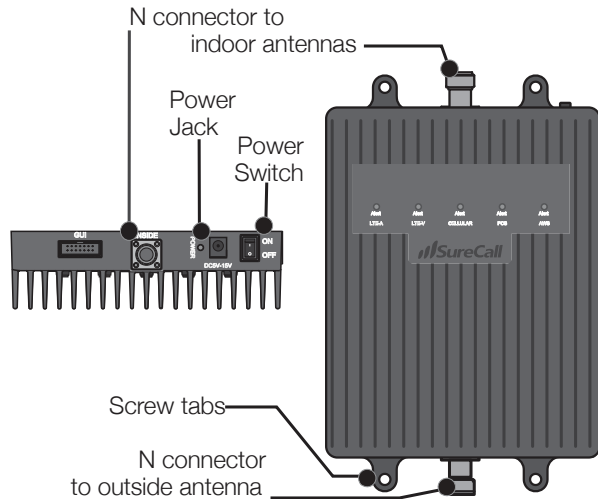

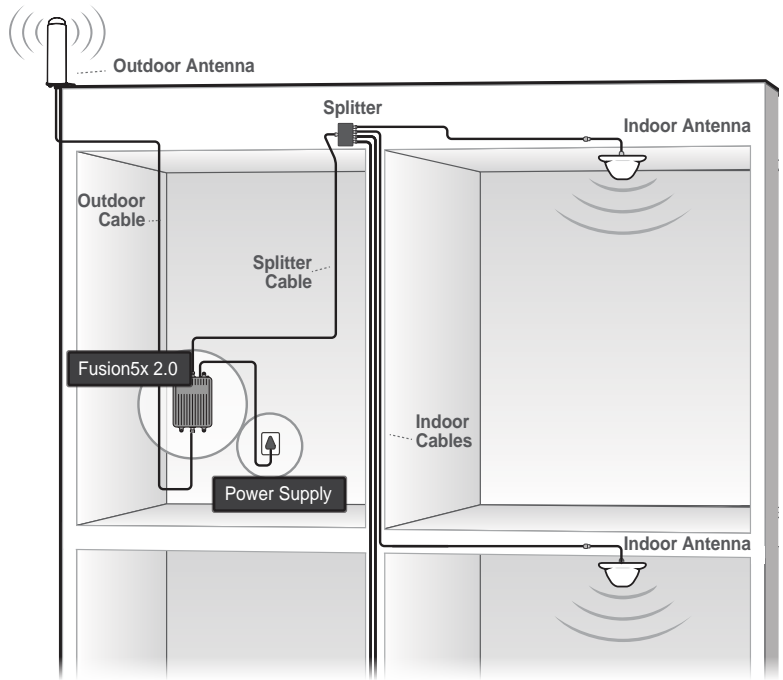

IF YOU WANT TO IMPROVE PERFORMANCE

1. Find a location that receives a stronger signal and relocate the outdoor antenna to that location.
2. Increase the distance between the outdoor and indoor antennas.
3. Visit www.surecall.com/support for installation tips, guides or to request support.

Note: This booster is rated for 5-20V input voltage. DO NOT use the booster with a higher voltage power supply. This can damage the booster, cause personal injury and void your warranty.

Installation

When reading the alert LEDs on your booster, please note the following information:

- Only the presence of red or yellow LEDs indicate the presence of an unresolved issue.
- Note that bars are not always a reliable measure of signal. The best way to confirm signal coverage is the ability to place and hold a call.



LED INFORMATION

LED Color	LED Condition	Indication / Resolution
Green	Solid	Indicates that the frequency band is in use. This is part of normal operation.
Green	Flashing	Indicates that the booster is functioning properly by using Automatic Gain Control (AGC) technology to stabilize the signal entering your booster from the outside antenna. This is part of normal operation.
Yellow	Flashing	Indicates that additional separation is recommended between the inside and outside antennas to optimize performance. Increased vertical separation is more effective than horizontal separation. If your booster kit uses two directional antennas (example: outside Yagi antenna and inside panel antenna), ensure that they are facing away from one another.
Yellow / Red	Alternately Flashing	This status appears when your booster is experiencing feedback. To resolve this additional separation is needed between the inside and outside antennas to ensure the frequency band will not shut-down. Increased vertical separation is more effective than horizontal separation. If your booster kit uses two directional antennas (example: outside Yagi antenna and inside panel antenna), ensure that they are facing away from one another.
Red	Flashing	The frequency band will shut-down due to too much signal entering the booster, causing it to over-power. To resolve, you can: <ol style="list-style-type: none">1. For kits using an OMNI outside antenna, relocate the outside antenna to a location where the signal is weaker.2. For kits using a YAGI outside antenna, turn the antenna in short increments away from the signal source.3. Add an inline attenuator to the cable coming into the outside port of the booster.4. For boosters with manual gain dials or switches, though not desirable as amplification will not be optimum, lower the dB gain setting in small increments until the light turns green.

TROUBLESHOOTING

Problem	Resolution
Signal booster has no power	<p>Verify that the booster switch is turned on.</p> <p>Be sure the power source is not controlled by a switch that can remove power from the outlet by connecting to an alternate power source.</p> <p>Check the POWER LED on the signal booster. If it is OFF. Contact tech support at: 1-888-365-6283 or support@surecall.com, or go to www.surecall.com/support to contact a representative.</p>
After installing your booster system, coverage has not improved.	<p>Verify that cable connections are tightly fitted to the booster and antennas.</p> <p>Check the installation of your outdoor antenna. Ensure that the mounting area is clear of obstructions and other radiating elements.</p> <p>For kits that use a directional Yagi antenna, verify that the antenna is properly aimed in the direction of your carrier's closest cell tower.</p> <p>Check the outdoor signal strength at the site the outdoor antenna. If signal level is low, your resulting coverage will be limited.</p> <p>Remember that Bars are not always a reliable measure of signal. The best way to confirm signal coverage is the ability to place and hold a call.</p>

SPECIFICATIONS

Fusion5X 2.0 Specifications	
Uplink Frequency Range (MHz):	698–716 / 776–787 / 824–849 / 1850–1915 / 1710–1755 (G Block Included)
Downlink Frequency Range (MHz):	728–746 / 746–757 / 869–894 / 1930–1995 / 2110–2155 (G Block Included)
Input / Output Impedance:	50 Ω
Maximum Gain:	72 dB
Noise Figure:	8 dB
Supported Standards:	CDMA, WCDMA, GSM, EDGE, HSPA+, EVDO, LTE and all cellular standards
AC Input:	Input AC 110 V, 60 Hz / Output DC 12 V
Maximum Output Power:	1 Watt EIRP
Downlink Power:	+16 dBm
Cable:	SC-400
RF Connectors:	N Female (both ends)
Power Consumption:	<25W
Operation Temperature:	-4° F to +158° F
Dimensions:	9.25 x 6.375 x 1.375 inches
Weight:	4.25 lbs
FCC:	RSNFUSION5S-X20
IC:	7784A-FUSIONX

Note: The term "IC" before the radio certification number only signifies that Industry Canada technical specifications were met.

15.105 This equipment has been tested and found to comply with the limits for a Class B digital device, pursuant to Part 15 of the FCC Rules. These limits are designed to provide reasonable protection against harmful interference in a residential installation. This equipment generates, uses and can radiate radio frequency energy and, if not installed and used in accordance with the instructions, may cause harmful interference to radio communications. However, there is no guarantee that interference will not occur in a particular installation. If this equipment does cause harmful interference to radio or television reception, which can be determined by turning the equipment off and on, the user is encouraged to try to correct the interference by one or more of the following measures:

- Reorient or relocate the receiving antenna.
- Increase the separation between the equipment and receiver.
- Connect the equipment into an outlet on a circuit different from that to which the receiver is connected.
- Consult the dealer or an experienced radio/TV technician for help.

Warning: Any product modifications that use unauthorized antennas, cables, and/or coupling devices are prohibited by the FCC. Contact FCC for details: 1-888-CALL-FCC. Changes or modifications not expressly approved by SureCall could void the user's authority to operate the equipment.

Kitting Information

Component	Prod No. Description	Gain/Loss				
		LTE-A	LTE-V	800MHz	1900MHz	1700MHz/2100MHz
Outdoor Antenna*	SC-288W	3 dBi	3 dBi	3 dBi	4 dBi	4 dBi / 4 dBi
	SC-230W	10 dBi	10 dBi	10 dBi	10 dBi	10 dBi / 10 dBi
Outdoor Cable*	SC-001-75	4.22 dB	4.22 dB	4.41 dB	6.17 dB	5.8 dB / 6.54 dB
Indoor Cable*	SC-001-30	2.05 dB	2.05 dB	2.12 dB	2.83 dB	2.68 dB / 2.98 dB
	SC-001-50	3.01 dB	3.01 dB	3.14 dB	4.31 dB	4.07 dB / 4.56dB
	SC-001-75	4.22 dB	4.22 dB	4.41 dB	6.17 dB	5.8 dB / 6.54 dB
	SC-001-100	6.02 dB	6.02 dB	6.28 dB	8.62 dB	8.14 dB / 9.12 dB
Indoor Antenna*	SC-222W	3 dBi	3 dBi	3 dBi	6 dBi	6 dBi / 6 dBi
	SC-228W	3.5 dBi	3.5 dBi	3.5 dBi	7.5 dBi	7.5 dBi / 7.5 dBi
	SC-248W	7 dBi	7 dBi	7 dBi	10 dBi	10 dBi / 10 dBi
4-way Splitter	SC-WS-4	-6.5 dB	-6.5 dB	-6.5 dB	-6.5 dB	-6.5 dB
* All equivalent antennas and cables are suitable for use with the Fusion5x 2.0 booster.						

WARRANTY

Three-Year Product Warranty

To activate your three-year manufacturer's warranty, register your booster at www.SureCall.com

SureCall warrants its products for three years from the date of purchase against defects in workmanship and/or materials. Specifications are subject to change. The three-year warranty only applies to products meeting the latest FCC Certification Guidelines stated on 2/20/2013 and going into effect April 30, 2014. A two-year warranty applies to any products manufactured before May 1, 2014.

Products returned by customers must be in their original, un-modified condition, shipped in the original or protective packaging with proof-of-purchase documentation enclosed, and a Return Merchandise Authorization (RMA) number printed clearly on the outside of the shipping container.

Buyers may obtain an RMA number for warranty returns by calling the SureCall Return Department toll-free at 1-888-365-6283. Any returns received by SureCall without an RMA number clearly printed on the outside of the shipping container will be returned to sender. In order to receive full credit for signal boosters, all accessories originally included in the signal booster box must be returned with the signal booster. (The Buyer does not need to include accessories sold in addition to the signal booster, such as antennas or cables.)

This warranty does not apply to any product determined by SureCall to have been subjected to misuse, abuse, neglect, or mishandling that alters or damages the product's physical or electronic properties.

SureCall warrants to the Buyer that each of its products, when shipped, will be free from defects in material and workmanship, and will perform in full accordance with applicable specifications. The limit of liability under this warranty is, at SureCall's option, to repair or replace any product or part thereof which was purchased up to THREE YEARS after May 1, 2014 or TWO YEARS for products purchased before May 1, 2014, as determined by examination by SureCall, prove defective in material and/or workmanship. Warranty returns must first be authorized in writing by SureCall. Disassembly of any SureCall product by anyone other than an authorized representative of SureCall voids this warranty in its entirety. SureCall reserves the right to make changes in any of its products without incurring any obligation to make the same changes on previously delivered products.

As a condition to the warranties provided for herein, the Buyer will prepay the shipping charges for all products returned to SureCall for repair, and SureCall will pay the return shipping with the exception of products returned from outside the United States, in which case the Buyer will pay the shipping charges.

The Buyer will pay the cost of inspecting and testing any goods returned under the warranty or otherwise, which are found to meet the applicable specifications or which are not defective or not covered by this warranty.

Products sold by SureCall shall not be considered defective or non-conforming to the Buyer's order if they satisfactorily fulfill the performance requirements that were published in the product specification literature, or in accordance with samples provided by SureCall. This warranty shall not apply to any products or parts thereof which have been subject to accident, negligence, alteration, abuse, or misuse. SureCall makes no warranty whatsoever in respect to accessories or parts not supplied by it.

Limitations of Warranty, Damages and Liability:

EXCEPT AS EXPRESSLY SET FORTH HEREIN, THERE ARE NO WARRANTIES, CONDITIONS, GUARANTEES, OR REPRESENTATIONS AS TO MERCHANTABILITY, FITNESS FOR A PARTICULAR PURPOSE, OR OTHER WARRANTIES, CONDITIONS, GUARANTEES, OR REPRESENTATIONS, WHETHER EXPRESSED OR IMPLIED, IN LAW OR IN FACT, ORAL OR IN WRITING.

SURECALL AGGREGATE LIABILITY IN DAMAGES OR OTHERWISE SHALL NOT EXCEED THE PAYMENT, IF ANY, RECEIVED BY CELLPHONE-MATE, INC. FOR THE UNIT OF PRODUCT OR SERVICE FURNISHED OR TO BE FURNISHED, AS THE CASE MAY BE, WHICH IS THE SUBJECT OF CLAIM OR DISPUTE. IN NO EVENT SHALL SURECALL BE LIABLE FOR INCIDENTAL, CONSEQUENTIAL, OR SPECIAL DAMAGES, HOWSOEVER CAUSED.

All matters regarding this warranty shall be interpreted in accordance with the laws of the State of California, and any controversy that cannot be settled directly shall be settled by arbitration in California in accordance with the rules then prevailing of the American Arbitration Association, and judgment upon the award rendered may be entered in any court having jurisdiction thereof. If one or more provisions provided herein are held to be invalid or unenforceable under applicable law, then such provision shall be ineffective and excluded to the extent of such invalidity or unenforceability without affecting in any way the remaining provisions hereof.

SureCall has made a good faith effort to ensure the accuracy of the information in this document and disclaims the implied warranties of merchantability and fitness for a particular purpose and makes no express warranties, except as may be stated in its written agreement with and for its customers. SureCall shall not be held liable to anyone for any indirect, special or consequential damages due to omissions or errors. The information and specifications in this document are subject to change without notice.

© 2018. All Rights Reserved. All trademarks and registered trademarks are the property of their respective owners.

CONSUMER GUIDELINES

This is a CONSUMER device

BEFORE USE, you MUST REGISTER THIS DEVICE with your wireless provider and have your provider's consent. Most wireless providers consent to the use of signal boosters. Some providers may not consent to the use of this device on their network. If you are unsure, contact your provider.

In Canada, BEFORE USE you must meet all requirements set out in ISED [CPC-2-1-05](#)¹

You MUST operate this device with approved antennas and cables as specified by the manufacturer. Antennas MUST be installed at least 20 cm (8 inches) from (i.e. MUST NOT be installed within 20 cm of) any person.

You MUST cease operation of this device immediately if requested by the FCC (or ISED in Canada) or a licensed wireless service provider.

WARNING: E911 location information may not be provided or may be inaccurate for calls served by using this device.

This device may operate in a fixed location only, for in-building use.

Ce produit est un appareil de CONSOMMATION

AVANT DE L'UTILISER, vous DEVEZ ENREGISTRER CE DISPOSITIF auprès de votre fournisseur de services cellulaires et obtenir son consentement. La plupart des fournisseurs de services cellulaires autorisent l'utilisation d'amplificateurs de signal. Il se peut que certains fournisseurs n'autorisent pas l'utilisation de ce dispositif sur leur réseau. Si vous n'êtes pas sûr, contactez-le.

Au Canada, AVANT DE L'UTILISER vous devez répondre à toutes les exigences ISED [CPC-2-1-05](#)²

Vous DEVEZ utiliser ce dispositif avec les antennes et les câbles autorisés, tel que le spécifie le fabricant. Les antennes DOIVENT être installées à au moins 20 cm (8 po) (NE DOIVENT PAS être installées à moins de 20 cm) de toute personne avoisinante.

Vous DEVEZ arrêter cet appareil immédiatement à la demande de la FCC (ISED au Canada) ou de tout fournisseur de services cellulaires autorisé.

AVERTISSEMENT: Il se peut que les informations relatives à la localisation E911 ne soient pas disponibles ou soient inexactes pour les appels qui utilisent cet appareil.

Cet appareil peut fonctionner seulement à un emplacement fixe à l'intérieur d'un bâtiment;

Register your cellular booster with your wireless carrier at the following urls:

Verizon: <http://www.verizonwireless.com/wcms/consumer/register-signal-booster.html>

AT&T: <https://securec45.securewebsession.com/attsignalbooster.com/>

T-Mobile: <https://support.t-mobile.com/docs/DOC-9827>

Sprint: https://www.sprint.com/legal/fcc_boosters.html

U.S. Cellular: <http://www.uscellular.com/uscellular/support/fcc-booster-registration.jsp>

This device complies with Part 15 of FCC Rules. Operation is subject to the following two conditions: (1) this device may not cause harmful interference, and (2) this device must accept any interference received, including interference that may cause undesired operation.

CAN ICES-3 (B)/NMB-3(B) (Canada) :

This Class B digital apparatus meets all requirements of the Canadian Interference Causing Equipment Regulations. Operation is subject to the following two conditions: (1) this device may not cause harmful interference, and (2) this device must accept any interference received, including interference that may cause undesired operation

The Manufacturer's rated output power of this equipment is for single carrier operation. For situations when multiple carrier signals are present, the rating would have to be reduced by 3.5 dB, especially where the output signal is re-radiated and can cause interference to adjacent band users. This power reduction is to be by means of input power or gain reduction and not by an attenuator at the output of the device.

Cet appareillage numérique de la classe B répond à toutes les exigences de l'interférence canadienne causant des réglemets d'équipement. L'opération est sujette aux deux conditions suivantes: (1) ce dispositif peut ne pas causer l'interférence nocive, et (2) ce dispositif doit accepter n'importe quelle interférence reçue, y compris l'interférence qui peut causer l'opération peu désirée.

La puissance de sortie nominale indiquée par le fabricant pour cet appareil concerne son fonctionnement avec porteuse unique. Pour des appareils avec porteurs multiples, on doit réduire la valeur nominale de 3,5 dB, surtout si le signal de sortie est retransmis et qu'il peut causer du brouillage aux utilisateurs de bandes adjacentes. Une telle réduction doit porter sur la puissance d'entrée ou sur le gain, et ne doit pas se faire au moyen d'un atténuateur raccordé à la sortie du dispositif.

[1] For details on the requirements specified in ISED CPC-2-1-05, visit: <http://www.ic.gc.ca/eic/site/smt-gst.nsf/eng/sf08942.html>

[2] Pour plus de détails sur les exigences ISED CPC-2-1-05, reportez-vous au site: <http://www.ic.gc.ca/eic/site/smt-gst.nsf/eng/sf08942.html>

48346 Milmont Drive
Fremont, California 94538, USA
888.365.6283
www.surecall.com